



Color**ONE**

strana 6

CZ Glazované keramické obkládačky s lesklým i matným povrchem v modulových formátech od 148 x 148 mm do 198 x 248 mm.

GB Glazed ceramic wall tiles in both glossy and matt surface in modular formats from 148 x 148 mm up to 198 x 248 mm.

PL Szklwiona glazura matowa lub błyszcząca o rozmiarach modularnych od 148 x 148 mm do 198 x 248 mm.

RUS Глазурованная керамическая плитка с глянцевой и матовой поверхностью производится в модулярных размерах от 148 x 148 мм до 198 x 248 мм.



Color**TWO**

strana 18

Glazované hutné dlaždice v modulových formátech od 23 x 23 mm do 297 x 297 mm.

Glazed ceramic floor tiles in modular formats from 23 x 23 mm up to 297 x 297 mm.

Szklwiona terakota spieczona o rozmiarach modularnych od 23x23 mm do 297x297 mm.

Глазурованная напольная керамическая плитка производится в модулярных размерах от 23 x 23 мм до 297 x 297 мм.

CZ

GB

PL

RUS

Harmonický design

Glazované obkládačky s lesklým nebo matným povrchem v modulových formátech od 148 x 148 mm do 198 x 248 mm.

Dokonalé barevné a formátové sladění s glazovanými dlaždicemi ColorTWO umožňuje vytváření mimořádných architektonických řešení.

A harmonic design

Glazed wall tiles with glossy or matt surface in modular formats from 148 x 148 mm up to 198 x 248 mm.

A perfect colour and format harmony with glazed tiles ColorTWO enables the creation of extraordinary architectonic solutions.

Harmoniczne wzornictwo

Szklwiona glazura matowa lub błyszcząca o rozmiarach modularnych od 148 x 148 mm do 198 x 248 mm.

Idealne kolorystyczne i wymiarowe zgranie ze szklwioną terakotą ColorTWO pozwala tworzyć wyjątkowe architektoniczne rozwiązania.

Гармония дизайна

Глазурованная настенная плитка с глянцевой или матовой поверхностью производится в модулярных размерах от 148x148 мм до 198x248 мм.

Благодаря сочетанию цветовой гаммы и комбинации размеров настенной плитки с глазурированной напольной плиткой программы ColorTwo возможно осуществить самые неординарные архитектурные решения.

ČSN EN 14411 annex L BIII GL	Povrch Surface Powierzchnia Поверхность	WHITE	0001500	0004000	0007000	0008500	0757030	0808020	0809005	0858070
14,8x14,8x0,6*	mat matt matowa матовый	WAA19104 ○ 64 m²	WAA19732 ○ 72 m²	WAA19765 ○ 72 m²	WAA19146 ○ 68 m²	WAA19135 ○ 66 m²	WAA19136 ○ 72 m²	WAA19134 ○ 68 m²	WAA19132 ○ 66 m²	WAA19222 ○ 72 m²
	lesk glossy błyszcząca глянцевый	WAA19000 ○ 64 m²	WAA19779 ○ 72 m²	WAA19755 ○ 72 m²	WAA19046 ○ 68 m²	WAA19035 ○ 66 m²	WAA19236 ○ 72 m²	WAA19223 ○ 68 m²	WAA19032 ○ 66 m²	WAA19201 ○ 72 m²
14,8x19,8x0,6	mat matt matowa матовый	WAADP104 ○ 68 m²			WAADP146 ○ 72 m²	WAADP135 ○ 72 m²			WAADP132 ○ 72 m²	
	lesk glossy błyszcząca глянцевый	WAADP000 ○ 68 m²			WAADP046 ○ 72 m²	WAADP035 ○ 72 m²			WAADP032 ○ 72 m²	
19,8x19,8x0,65*	mat matt matowa матовый	WAA1N104 ○ 68 m²	WAA1N732 ○ 74 m²	WAA1N765 ○ 74 m²	WAA1N146 ○ 72 m²	WAA1N135 ○ 72 m²	WAA1N136 ○ 74 m²	WAA1N134 ○ 72 m²	WAA1N132 ○ 72 m²	WAA1N222 ○ 74 m²
	lesk glossy błyszcząca глянцевый	WAA1N000 ○ 68 m²	WAA1N779 ○ 74 m²	WAA1N755 ○ 74 m²	WAA1N046 ○ 72 m²	WAA1N035 ○ 72 m²	WAA1N236 ○ 74 m²	WAA1N223 ○ 72 m²	WAA1N032 ○ 72 m²	WAA1N201 ○ 74 m²
19,8x24,8x0,68	mat matt matowa матовый	WAAG6104 ○ 68 m²			WAAG6146 ○ 72 m²	WAAG6135 ○ 72 m²			WAAG6132 ○ 72 m²	
	lesk glossy błyszcząca глянцевый	WAAG6000 ○ 68 m²			WAAG6046 ○ 72 m²	WAAG6035 ○ 72 m²			WAAG6032 ○ 72 m²	
19,8x1,2x0,65 <small>listela listel</small>	lesk glossy błyszcząca глянцевый		WLADD779 ○ 28 ks		WLADD046 ○ 28 ks		WLADD236 ○ 28 ks			
19,8x2,5x0,65 <small>listela listel</small>	lesk glossy błyszcząca глянцевый		WLADG779 ○ 32 ks		WLADG046 ○ 32 ks		WLADG236 ○ 32 ks			

* 10% podíl výrobků s přeglazovanou hranou | 10% pieces with overglazed edges | 10% sztuk z przeszklwionymi krawędziami | 10% доля изделий с глазурованной боковой поверхностью

0908040	1009010	0607050	0608040	0709020	0304060	0307030	0308010	1605015	1507030	1509010	2902035	2606025	2408015
WAA19221 ○ 68 m²	WAA19220 ○ 66 m²	WAA19282 ○ 72 m²	WAA19281 ○ 68 m²	WAA19280 ○ 66 m²		WAA19381 ○ 68 m²	WAA19380 ○ 66 m²	WAA19472 ○ 72 m²	WAA19471 ○ 68 m²	WAA19470 ○ 66 m²	WAA19545 ○ 72 m²	WAA19541 ○ 68 m²	WAA19540 ○ 66 m²
WAA19200 ○ 68 m²	WAA19110 ○ 66 m²	WAA19272 ○ 72 m²	WAA19271 ○ 68 m²	WAA19270 ○ 66 m²	WAA19363 ○ 76 m²	WAA19371 ○ 68 m²	WAA19370 ○ 66 m²	WAA19443 ○ 72 m²	WAA19441 ○ 68 m²	WAA19440 ○ 66 m²	WAA19555 ○ 72 m²	WAA19551 ○ 68 m²	WAA19550 ○ 66 m²
WAA1N221 ○ 72 m²	WAA1N220 ○ 72 m²	WAA1N282 ○ 74 m²	WAA1N281 ○ 72 m²	WAA1N280 ○ 72 m²		WAA1N381 ○ 72 m²	WAA1N380 ○ 72 m²	WAA1N472 ○ 74 m²	WAA1N471 ○ 72 m²	WAA1N470 ○ 72 m²	WAA1N545 ○ 74 m²	WAA1N541 ○ 72 m²	WAA1N540 ○ 72 m²
WAA1N200 ○ 72 m²	WAA1N110 ○ 72 m²	WAA1N272 ○ 74 m²	WAA1N271 ○ 72 m²	WAA1N270 ○ 72 m²	WAA1N363 ○ 80 m²	WAA1N371 ○ 72 m²	WAA1N370 ○ 72 m²	WAA1N443 ○ 74 m²	WAA1N441 ○ 72 m²	WAA1N440 ○ 72 m²	WAA1N555 ○ 74 m²	WAA1N551 ○ 72 m²	WAA1N550 ○ 72 m²
					WLADD363 ○ 28 ks			WLADD443 ○ 28 ks			WLADD555 ○ 28 ks		WLADD550 ○ 28 ks
					WLADG363 ○ 32 ks			WLADG443 ○ 32 ks			WLADG555 ○ 32 ks		WLADG550 ○ 32 ks



Barevné odstíny a RAL kódy, které jsou zde vyobrazeny, mají pouze orientační charakter. | The shown shades of the tiles and RAL design are only to the orientation. | Prezentowane kolory płytek a RAL kody są orientacyjne. | Цвoбpaжeннe oттeнки цвeтoв a RAL кoды имeют лишь ориeнтaциoнный хaрaктер.

RAL kód | RAL Design | RAL kod | RAL код

ColorONE

ČSN EN 14411 annex L BIII GL

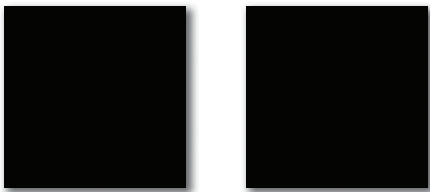
Katalogové číslo Catalog number Numer katalogowy Артикул	Rozměr Barva Povrch Size Colour Surface Wymiar Kolor Powierzchnia Размер Цвет Поверхность	Cenová skupina Price group Grupa cenowa Ценовая группа	m ²	Karton Carton Karton Коробка	Paleta Pallet Paleta Поддон
				m ²	m ²
			kg	kg	kg
			Ks Pcs. Szt. Шт.	Ks Pcs. Szt. Шт.	Karton Carton Karton Коробка

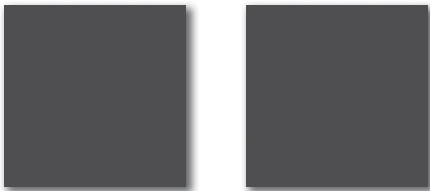
 <p>RAL 0001500 RAL 0001500</p>	WAA19732*	14,8 x 14,8 x 0,6 cm RAL 0001500 mat matt matova матовый	72 m ²	– 10,5 44	1,00 10,5 44	100,00 1.083 100
	WAA19779*	14,8 x 14,8 x 0,6 cm RAL 0001500 lesk glossy błyszcząca глянцевый	72 m ²	– 10,5 44	1,00 10,5 44	100,00 1.083 100
	WAA1N732*	19,8 x 19,8 x 0,65 cm RAL 0001500 mat matt matova матовый	74 m ²	– 12,2 25	1,00 12,2 25	84,00 1.057 84
	WAA1N779*	19,8 x 19,8 x 0,65 cm RAL 0001500 lesk glossy błyszcząca глянцевый	74 m ²	– 12,2 25	1,00 12,2 25	84,00 1.057 84
	WAA19104*	14,8 x 14,8 x 0,6 cm WHITE mat matt matova матовый	64 m ²	– 10,5 44	1,00 10,5 44	100,00 1.083 100
	WAA19000*	14,8 x 14,8 x 0,6 cm WHITE lesk glossy błyszcząca глянцевый	64 m ²	– 10,5 44	1,00 10,5 44	100,00 1.083 100
 <p>WHITE WHITE</p>	WAADP104	14,8 x 19,8 x 0,6 cm WHITE mat matt matova матовый	68 m ²	– 11,0 33	1,00 11,0 33	100,00 1.133 100
	WAADP000	14,8 x 19,8 x 0,6 cm WHITE lesk glossy błyszcząca глянцевый	68 m ²	– 11,0 33	1,00 11,0 33	100,00 1.133 100
	WAA1N104*	19,8 x 19,8 x 0,65 cm WHITE mat matt matova матовый	68 m ²	– 12,2 25	1,00 12,2 25	84,00 1.057 84
	WAA1N000*	19,8 x 19,8 x 0,65 cm WHITE lesk glossy błyszcząca глянцевый	68 m ²	– 12,2 25	1,00 12,2 25	84,00 1.057 84
	WAAG6104	19,8 x 24,8 x 0,68 cm WHITE mat matt matova матовый	68 m ²	– 11,4 20	1,50 17,1 30	90,00 1.055 60
	WAAG6000	19,8 x 24,8 x 0,68 cm WHITE lesk glossy błyszcząca глянцевый	68 m ²	– 11,4 20	1,50 17,1 30	90,00 1.055 60
 <p>RAL 0004000 RAL 0004000</p>	WAA19765*	14,8 x 14,8 x 0,6 cm RAL 0004000 mat matt matova матовый	72 m ²	– 10,5 44	1,00 10,5 44	100,00 1.083 100
	WAA19755*	14,8 x 14,8 x 0,6 cm RAL 0004000 lesk glossy błyszcząca глянцевый	72 m ²	– 10,5 44	1,00 10,5 44	100,00 1.083 100
	WAA1N765*	19,8 x 19,8 x 0,65 cm RAL 0004000 mat matt matova матовый	74 m ²	– 12,2 25	1,00 12,2 25	84,00 1.057 84
	WAA1N755*	19,8 x 19,8 x 0,65 cm RAL 0004000 lesk glossy błyszcząca глянцевый	74 m ²	– 12,2 25	1,00 12,2 25	84,00 1.057 84

* 10% podíl výrobků s přeglazovanou hranou | 10% pieces with overglazed edges | 10% sztuk z przeszklwionymi krawędziami | 10% доля изделий с глазурованной боковой поверхностью

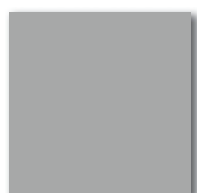

RAL 0007000

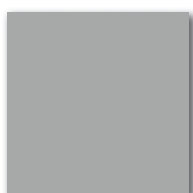

RAL 0007000

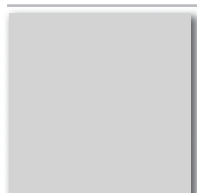

RAL 0008500

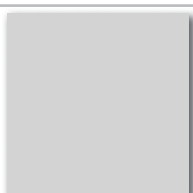



RAL 0008500

Katalogové číslo Catalog number Numer katalogowy Артикул	Rozměr Barva Povrch Size Colour Surface Wymiar Kolor Powierzchnia Размер Цвет Поверхность	Cenová skupina Price group Grupa cenowa Ценовая группа	m ²	Karton Carton Karton Коробка	Paleta Pallet Paleta Поддон
				m ²	m ²
			kg	kg	kg
			Ks Pcs. Szt. Шт.	Ks Pcs. Szt. Шт.	Karton Carton Karton Коробка
WAA19146*	14,8 x 14,8 x 0,6 cm RAL 0007000 mat matt matova матовый	68 m ²	-	1,00	100,00
			10,5	10,5	1.083
			44	44	100
WAA19046*	14,8 x 14,8 x 0,6 cm RAL 0007000 lesk glossy błyszcząca глянцевый	68 m ²	-	1,00	100,00
			10,5	10,5	1.083
			44	44	100
WAADP146	14,8 x 19,8 x 0,6 cm RAL 0007000 mat matt matova матовый	72 m ²	-	1,00	100,00
			11,0	11,0	1.133
			33	33	100
WAADP046	14,8 x 19,8 x 0,6 cm RAL 0007000 lesk glossy błyszcząca глянцевый	72 m ²	-	1,00	100,00
			11,0	11,0	1.133
			33	33	100
WAA1N146*	19,8 x 19,8 x 0,65 cm RAL 0007000 mat matt matova матовый	72 m ²	-	1,00	84,00
			12,2	12,2	1.057
			25	25	84
WAA1N046*	19,8 x 19,8 x 0,65 cm RAL 0007000 lesk glossy błyszcząca глянцевый	72 m ²	-	1,00	84,00
			12,2	12,2	1.057
			25	25	84
WAAG6146	19,8 x 24,8 x 0,68 cm RAL 0007000 mat matt matova матовый	72 m ²	-	1,50	90,00
			11,4	17,1	1.055
			20	30	60
WAAG6046	19,8 x 24,8 x 0,68 cm RAL 0007000 lesk glossy błyszcząca глянцевый	72 m ²	-	1,50	90,00
			11,4	17,1	1.055
			20	30	60
WAA19135*	14,8 x 14,8 x 0,6 cm RAL 0008500 mat matt matova матовый	66 m ²	-	1,00	100,00
			10,5	10,5	1.083
			44	44	100
WAA19035*	14,8 x 14,8 x 0,6 cm RAL 0008500 lesk glossy błyszcząca глянцевый	66 m ²	-	1,00	100,00
			10,5	10,5	1.083
			44	44	100
WAADP135	14,8 x 19,8 x 0,6 cm RAL 0008500 mat matt matova матовый	72 m ²	-	1,00	100,00
			11,0	11,0	1.133
			33	33	100
WAADP035	14,8 x 19,8 x 0,6 cm RAL 0008500 lesk glossy błyszcząca глянцевый	72 m ²	-	1,00	100,00
			11,0	11,0	1.133
			33	33	100
WAA1N135*	19,8 x 19,8 x 0,65 cm RAL 0008500 mat matt matova матовый	72 m ²	-	1,00	84,00
			12,2	12,2	1.057
			25	25	84
WAA1N035*	19,8 x 19,8 x 0,65 cm RAL 0008500 lesk glossy błyszcząca глянцевый	72 m ²	-	1,00	84,00
			12,2	12,2	1.057
			25	25	84
WAAG6135	19,8 x 24,8 x 0,68 cm RAL 0008500 mat matt matova матовый	72 m ²	-	1,50	90,00
			11,4	17,1	1.055
			20	30	60
WAAG6035	19,8 x 24,8 x 0,68 cm RAL 0008500 lesk glossy błyszcząca глянцевый	72 m ²	-	1,50	90,00
			11,4	17,1	1.055
			20	30	60

ColorONE

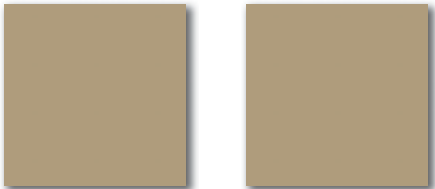
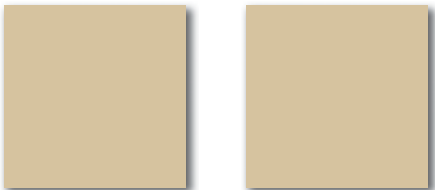
ČSN EN 14411 annex L BIII GL

Katalogové číslo Catalog number Numer katalogowy Артикул	Rozměr Barva Povrch Size Colour Surface Wymiar Kolor Powierzchnia Размер Цвет Поверхность	Cenová skupina Price group Grupa cenowa Ценовая группа	m ²	Karton Carton Karton Коробка	Paleta Pallet Paleta Поддон	
				m ²	m ²	
			kg	kg	kg	
			Ks Pcs. Szt. Шт.	Ks Pcs. Szt. Шт.	Karton Carton Karton Коробка	
 RAL 0757030 RAL 0757030	WAA19136*	14,8 x 14,8 x 0,6 cm RAL 0757030 mat matt matova матовый	72 m ²	– 10,5 44	1,00 10,5 44	100,00 1.083 100
	WAA19236*	14,8 x 14,8 x 0,6 cm RAL 0757030 lesk glossy błyszcząca глянцевый	72 m ²	– 10,5 44	1,00 10,5 44	100,00 1.083 100
	WAA1N136*	19,8 x 19,8 x 0,65 cm RAL 0757030 mat matt matova матовый	74 m ²	– 12,2 25	1,00 12,2 25	84,00 1.057 84
	WAA1N236*	19,8 x 19,8 x 0,65 cm RAL 0757030 lesk glossy błyszcząca глянцевый	74 m ²	– 12,2 25	1,00 12,2 25	84,00 1.057 84
	WAA19134*	14,8 x 14,8 x 0,6 cm RAL 0808020 mat matt matova матовый	68 m ²	– 10,5 44	1,00 10,5 44	100,00 1.083 100
	WAA19223*	14,8 x 14,8 x 0,6 cm RAL 0808020 lesk glossy błyszcząca глянцевый	68 m ²	– 10,5 44	1,00 10,5 44	100,00 1.083 100
 RAL 0808020 RAL 0808020	WAA1N134*	19,8 x 19,8 x 0,65 cm RAL 0808020 mat matt matova матовый	72 m ²	– 12,2 25	1,00 12,2 25	84,00 1.057 84
	WAA1N223*	19,8 x 19,8 x 0,65 cm RAL 0808020 lesk glossy błyszcząca глянцевый	72 m ²	– 12,2 25	1,00 12,2 25	84,00 1.057 84
	WAA19132*	14,8 x 14,8 x 0,6 cm RAL 0809005 mat matt matova матовый	66 m ²	– 10,5 44	1,00 10,5 44	100,00 1.083 100
	WAA19032*	14,8 x 14,8 x 0,6 cm RAL 0809005 lesk glossy błyszcząca глянцевый	66 m ²	– 10,5 44	1,00 10,5 44	100,00 1.083 100
	WAADP132	14,8 x 19,8 x 0,6 cm RAL 0809005 mat matt matova матовый	72 m ²	– 11,0 33	1,00 11,0 33	100,00 1.133 100
	WAADP032	14,8 x 19,8 x 0,6 cm RAL 0809005 lesk glossy błyszcząca глянцевый	72 m ²	– 11,0 33	1,00 11,0 33	100,00 1.133 100
 RAL 0809005 RAL 0809005	WAA1N132*	19,8 x 19,8 x 0,65 cm RAL 0809005 mat matt matova матовый	72 m ²	– 12,2 25	1,00 12,2 25	84,00 1.057 84
	WAA1N032*	19,8 x 19,8 x 0,65 cm RAL 0809005 lesk glossy błyszcząca глянцевый	72 m ²	– 12,2 25	1,00 12,2 25	84,00 1.057 84
	WAAG6132	19,8 x 24,8 x 0,68 cm RAL 0809005 mat matt matova матовый	72 m ²	– 11,4 20	1,50 17,1 30	90,00 1.055 60

* 10% podíl výrobků s přeglazovanou hranou | 10% pieces with overglazed edges | 10% sztuk z przeszklwionymi krawędziami | 10% доля изделий с глазурованной боковой поверхностью

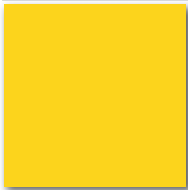
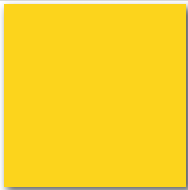
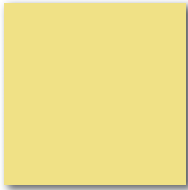
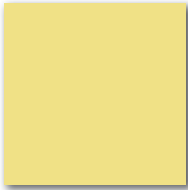
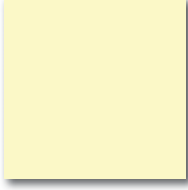
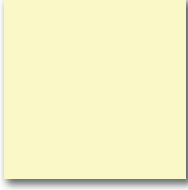
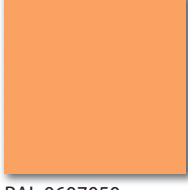
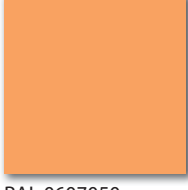
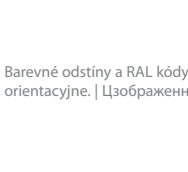
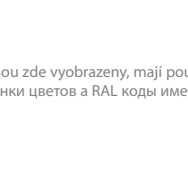
Katalogové číslo Catalog number Numer katalogowy Артикул	Rozměr Barva Povrch Size Colour Surface Wymiar Kolor Powierzchnia Размер Цвет Поверхность	Cenová skupina Price group Grupa cenowa Ценовая группа	m ²	Karton Carton Karton Коробка	Paleta Pallet Paleta Поддон
				m ²	m ²
			kg	kg	kg
Ks Pcs. Szt. Шт.	Ks Pcs. Szt. Шт.	Karton Carton Karton Коробка			
WAAG6032	19,8 x 24,8 x 0,68 cm RAL 0809005 lesk glossy błyszcząca глянцевый	72 m ²	–	1,50	90,00
			11,4	17,1	1.055
			20	30	60
WAA19222*  RAL 0858070	14,8 x 14,8 x 0,6 cm RAL 0858070 mat matt matowa матовый	72 m ²	–	1,00	100,00
			10,5	10,5	1.083
			44	44	100
WAA19201*  RAL 0858070	14,8 x 14,8 x 0,6 cm RAL 0858070 lesk glossy błyszcząca глянцевый	72 m ²	–	1,00	100,00
			10,5	10,5	1.083
			44	44	100
WAA1N222*  RAL 0908040	19,8 x 19,8 x 0,65 cm RAL 0858070 mat matt matowa матовый	74 m ²	–	1,00	84,00
			12,2	12,2	1.057
			25	25	84
WAA1N201*  RAL 0908040	19,8 x 19,8 x 0,65 cm RAL 0858070 lesk glossy błyszcząca глянцевый	74 m ²	–	1,00	84,00
			12,2	12,2	1.057
			25	25	84
WAA19221*  RAL 1009010	14,8 x 14,8 x 0,6 cm RAL 0908040 mat matt matowa матовый	68 m ²	–	1,00	100,00
			10,5	10,5	1.083
			44	44	100
WAA19200*  RAL 1009010	14,8 x 14,8 x 0,6 cm RAL 0908040 lesk glossy błyszcząca глянцевый	68 m ²	–	1,00	100,00
			10,5	10,5	1.083
			44	44	100
WAA1N221*  RAL 0607050	19,8 x 19,8 x 0,65 cm RAL 0908040 mat matt matowa матовый	72 m ²	–	1,00	84,00
			12,2	12,2	1.057
			25	25	84
WAA1N200*  RAL 0607050	19,8 x 19,8 x 0,65 cm RAL 0908040 lesk glossy błyszcząca глянцевый	72 m ²	–	1,00	84,00
			12,2	12,2	1.057
			25	25	84
WAA19220*  RAL 0607050	14,8 x 14,8 x 0,6 cm RAL 1009010 mat matt matowa матовый	66 m ²	–	1,00	100,00
			10,5	10,5	1.083
			44	44	100
WAA19110*  RAL 0607050	14,8 x 14,8 x 0,6 cm RAL 1009010 lesk glossy błyszcząca глянцевый	66 m ²	–	1,00	100,00
			10,5	10,5	1.083
			44	44	100
WAA1N220* RAL 0607050	19,8 x 19,8 x 0,65 cm RAL 1009010 mat matt matowa матовый	72 m ²	–	1,00	84,00
			12,2	12,2	1.057
			25	25	84
WAA1N110* RAL 0607050	19,8 x 19,8 x 0,65 cm RAL 1009010 lesk glossy błyszcząca глянцевый	72 m ²	–	1,00	84,00
			12,2	12,2	1.057
			25	25	84
WAA19282* RAL 0607050	14,8 x 14,8 x 0,6 cm RAL 0607050 mat matt matowa матовый	72 m ²	–	1,00	100,00
			10,5	10,5	1.083
			44	44	100
WAA19272* RAL 0607050	14,8 x 14,8 x 0,6 cm RAL 0607050 lesk glossy błyszcząca глянцевый	72 m ²	–	1,00	100,00
			10,5	10,5	1.083
			44	44	100

Barevné odstíny a RAL kódy, které jsou zde vyobrazeny, mají pouze orientační charakter. | The shown shades of the tiles and RAL design are only to the orientation. | Prezentowane kolory płytek a RAL kody są orientacyjne. | Цображэнныя адтэнкі колераў а RAL коды маюць толькі арыентацыйны характар.



RAL kód | RAL Design | RAL kod | RAL код

ColorONE

ČSN EN 14411 annex L BIII GL

Katalogové číslo Catalog number Numer katalogowy Артикул	Rozměr Barva Povrch Size Colour Surface Wymiar Kolor Powierzchnia Размер Цвет Поверхность	Cenová skupina Price group Grupa cenowa Ценовая группа	m ²	Karton Carton Karton Коробка	Paleta Pallet Paleta Поддон	
				m ²	m ²	
			kg	kg	kg	
			Ks Pcs. Szt. Шт.	Ks Pcs. Szt. Шт.	Karton Carton Karton Коробка	
WAA1N282*	19,8 x 19,8 x 0,65 cm RAL 0607050 mat matt matova матовый	74 m ²	–	1,00	84,00	
			12,2	12,2	1.057	
			25	25	84	
	WAA1N272*	19,8 x 19,8 x 0,65 cm RAL 0607050 lesk glossy błyszcząca глянцевый	74 m ²	–	1,00	84,00
				12,2	12,2	1.057
				25	25	84
WAA19281*	14,8 x 14,8 x 0,6 cm RAL 0608040 mat matt matova матовый	68 m ²	–	1,00	100,00	
			10,5	10,5	1.083	
			44	44	100	
	WAA19271*	14,8 x 14,8 x 0,6 cm RAL 0608040 lesk glossy błyszcząca глянцевый	68 m ²	–	1,00	100,00
				10,5	10,5	1.083
				44	44	100
WAA1N281*	19,8 x 19,8 x 0,65 cm RAL 0608040 mat matt matova матовый	72 m ²	–	1,00	84,00	
			12,2	12,2	1.057	
			25	25	84	
	WAA1N271*	19,8 x 19,8 x 0,65 cm RAL 0608040 lesk glossy błyszcząca глянцевый	72 m ²	–	1,00	84,00
				12,2	12,2	1.057
				25	25	84
WAA19280*	14,8 x 14,8 x 0,6 cm RAL 0709020 mat matt matova матовый	66 m ²	–	1,00	100,00	
			10,5	10,5	1.083	
			44	44	100	
	WAA19270*	14,8 x 14,8 x 0,6 cm RAL 0709020 lesk glossy błyszcząca глянцевый	66 m ²	–	1,00	100,00
				10,5	10,5	1.083
				44	44	100
WAA1N280*	19,8 x 19,8 x 0,65 cm RAL 0709020 mat matt matova матовый	72 m ²	–	1,00	84,00	
			12,2	12,2	1.057	
			25	25	84	
	WAA1N270*	19,8 x 19,8 x 0,65 cm RAL 0709020 lesk glossy błyszcząca глянцевый	72 m ²	–	1,00	84,00
				12,2	12,2	1.057
				25	25	84
WAA19363*	14,8 x 14,8 x 0,6 cm RAL 0304060 lesk glossy błyszcząca глянцевый	76 m ²	–	1,00	100,00	
			10,5	10,5	1.083	
			44	44	100	
WAA1N363*	19,8 x 19,8 x 0,65 cm RAL 0304060 lesk glossy błyszcząca глянцевый	80 m ²	–	1,00	84,00	
			12,2	10,5	1.057	
			25	44	84	
WAA19381*	14,8 x 14,8 x 0,6 cm RAL 0307030 mat matt matova матовый	68 m ²	–	1,00	100,00	
			10,5	10,5	1.083	
			44	44	100	
	WAA19371*	14,8 x 14,8 x 0,6 cm RAL 0307030 lesk glossy błyszcząca глянцевый	68 m ²	–	1,00	100,00
				10,5	10,5	1.083
				44	44	100
WAA1N381*	19,8 x 19,8 x 0,65 cm RAL 0307030 mat matt matova матовый	72 m ²	–	1,00	84,00	
			12,2	12,2	1.057	
			25	25	84	

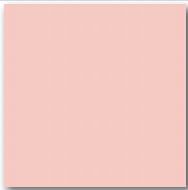
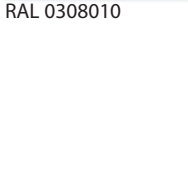
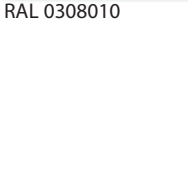
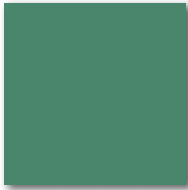
* 10% podíl výrobků s přeglazovanou hranou | 10% pieces with overglazed edges | 10% sztuk z przeszklwionymi krawędziami | 10% доля изделий с глазурованной боковой поверхностью

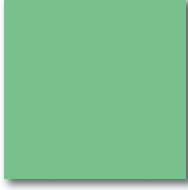
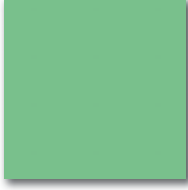
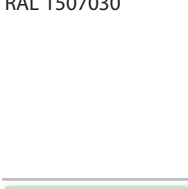
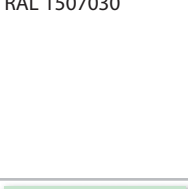
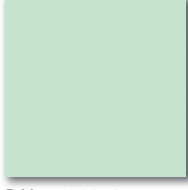
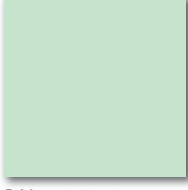
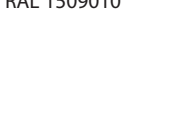
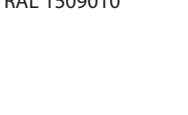
	Katalogové číslo Catalog number Numer katalogowy Артикул	Rozměr Barva Povrch Size Colour Surface Wymiar Kolor Powierzchnia Размер Цвет Поверхность	Cenová skupina Price group Grupa cenowa Ценовая группа	m ²	Karton Carton Karton Коробка	Paleta Pallet Paleta Поддон
					m ²	m ²
				kg	kg	kg
				Ks Pcs. Szt. Шт.	Ks Pcs. Szt. Шт.	Karton Carton Karton Коробка
	WAA1N371*	19,8 x 19,8 x 0,65 cm RAL 0307030 lesk glossy błyszcząca глянцевый	72 m ²	–	1,00	84,00
				12,2	12,2	1.057
				25	25	84
	WAA19380*	14,8 x 14,8 x 0,6 cm RAL 0308010 mat matt matowa матовый	66 m ²	–	1,00	100,00
				10,5	10,5	1.083
				44	44	100
	WAA19370*	14,8 x 14,8 x 0,6 cm RAL 0308010 lesk glossy błyszcząca глянцевый	66 m ²	–	1,00	100,00
				10,5	10,5	1.083
				44	44	100
	WAA1N380*	19,8 x 19,8 x 0,65 cm RAL 0308010 mat matt matowa матовый	72 m ²	–	1,00	84,00
				12,2	12,2	1.057
				25	25	84
	WAA1N370*	19,8 x 19,8 x 0,65 cm RAL 0308010 lesk glossy błyszcząca глянцевый	72 m ²	–	1,00	84,00
				12,2	12,2	1.057
				25	25	84
	WAA19472*	14,8 x 14,8 x 0,6 cm RAL 1605015 mat matt matowa матовый	72 m ²	–	1,00	100,00
				10,5	10,5	1.083
				44	44	100
	WAA19443*	14,8 x 14,8 x 0,6 cm RAL 1605015 lesk glossy błyszcząca глянцевый	72 m ²	–	1,00	100,00
				10,5	10,5	1.083
				44	44	100
	WAA1N472*	19,8 x 19,8 x 0,65 cm RAL 1605015 mat matt matowa матовый	74 m ²	–	1,00	84,00
				12,2	12,2	1.057
				25	25	84
	WAA1N443*	19,8 x 19,8 x 0,65 cm RAL 1605015 lesk glossy błyszcząca глянцевый	74 m ²	–	1,00	84,00
				12,2	12,2	1.057
				25	25	84
	WAA19471*	14,8 x 14,8 x 0,6 cm RAL 1507030 mat matt matowa матовый	68 m ²	–	1,00	100,00
				10,5	10,5	1.083
				44	44	100
	WAA19441*	14,8 x 14,8 x 0,6 cm RAL 1507030 lesk glossy błyszcząca глянцевый	68 m ²	–	1,00	100,00
				10,5	10,5	1.083
				44	44	100
	WAA1N471*	19,8 x 19,8 x 0,65 cm RAL 1507030 mat matt matowa матовый	72 m ²	–	1,00	84,00
				12,2	12,2	1.057
				25	25	84
	WAA1N441*	19,8 x 19,8 x 0,65 cm RAL 1507030 lesk glossy błyszcząca глянцевый	72 m ²	–	1,00	84,00
				12,2	12,2	1.057
				25	25	84
	WAA19470*	14,8 x 14,8 x 0,6 cm RAL 1509010 mat matt matowa матовый	66 m ²	–	1,00	100,00
				10,5	10,5	1.083
				44	44	100
	WAA19440*	14,8 x 14,8 x 0,6 cm RAL 1509010 lesk glossy błyszcząca глянцевый	66 m ²	–	1,00	100,00
				10,5	10,5	1.083
				44	44	100

Barevné odstíny a RAL kódy, které jsou zde vyobrazeny, mají pouze orientační charakter. | The shown shades of the tiles and RAL design are only to the orientation. | Prezentowane kolory płytek a RAL kody są orientacyjne. | Цюбарженныя атонаквы і RAL коды маюць толькі арыентацыйны характар.

RAL kód | RAL Design | RAL kod | RAL код

ColorONE

ČSN EN 14411 annex L BIII GL

Katalogové číslo Catalog number Numer katalogowy Артикул	Rozměr Barva Povrch Size Colour Surface Wymiar Kolor Powierzchnia Размер Цвет Поверхность	Cenová skupina Price group Grupa cenowa Ценовая группа	m ²	Karton Carton Karton Коробка	Paleta Pallet Paleta Поддон	
				m ²	m ²	
			kg	kg	kg	
			Ks Pcs. Szt. Шт.	Ks Pcs. Szt. Шт.	Karton Carton Karton Коробка	
WAA1N470*	19,8 x 19,8 x 0,65 cm RAL 1509010 mat matt matova матовый	72 m ²	–	1,00	84,00	
			12,2	12,2	1.057	
			25	25	84	
	WAA1N440*	19,8 x 19,8 x 0,65 cm RAL 1509010 lesk glossy błyszcząca глянцевый	72 m ²	–	1,00	84,00
				12,2	12,2	1.057
				25	25	84
WAA19545*	14,8 x 14,8 x 0,6 cm RAL 2902035 mat matt matova матовый	72 m ²	–	1,00	100,00	
			10,5	10,5	1.083	
			44	44	100	
	WAA19555*	14,8 x 14,8 x 0,6 cm RAL 2902035 lesk glossy błyszcząca глянцевый	72 m ²	–	1,00	100,00
				10,5	10,5	1.083
				44	44	100
WAA1N545*	19,8 x 19,8 x 0,65 cm RAL 2902035 mat matt matova матовый	74 m ²	–	1,00	84,00	
			12,2	12,2	1.057	
			25	25	84	
	WAA1N555*	19,8 x 19,8 x 0,65 cm RAL 2902035 lesk glossy błyszcząca глянцевый	74 m ²	–	1,00	84,00
				12,2	12,2	1.057
				25	25	84
WAA19541*	14,8 x 14,8 x 0,6 cm RAL 2606025 mat matt matova матовый	68 m ²	–	1,00	100,00	
			10,5	10,5	1.083	
			44	44	100	
	WAA19551*	14,8 x 14,8 x 0,6 cm RAL 2606025 lesk glossy błyszcząca глянцевый	68 m ²	–	1,00	100,00
				10,5	10,5	1.083
				44	44	100
WAA1N541*	19,8 x 19,8 x 0,65 cm RAL 2606025 mat matt matova матовый	72 m ²	–	1,00	84,00	
			12,2	12,2	1.057	
			25	25	84	
	WAA1N551*	19,8 x 19,8 x 0,65 cm RAL 2606025 lesk glossy błyszcząca глянцевый	72 m ²	–	1,00	84,00
				12,2	12,2	1.057
				25	25	84
WAA19540*	14,8 x 14,8 x 0,6 cm RAL 2408015 mat matt matova матовый	66 m ²	–	1,00	100,00	
			10,5	12,2	1.083	
			44	25	100	
	WAA19550*	14,8 x 14,8 x 0,6 cm RAL 2408015 lesk glossy błyszcząca глянцевый	66 m ²	–	1,00	100,00
				10,5	12,2	1.083
				44	25	100
WAA1N540*	19,8 x 19,8 x 0,65 cm RAL 2408015 mat matt matova матовый	72 m ²	–	1,00	84,00	
			12,2	12,2	1.057	
			25	25	84	
WAA1N550*	19,8 x 19,8 x 0,65 cm RAL 2408015 lesk glossy błyszcząca глянцевый	72 m ²	–	1,00	84,00	
			12,2	12,2	1.057	
			25	25	84	

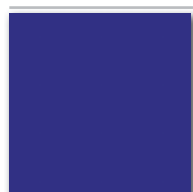

RAL 2902035

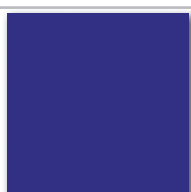

RAL 2902035

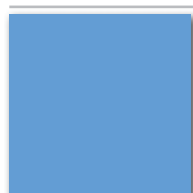

RAL 2606025

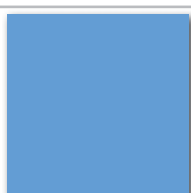

RAL 2606025

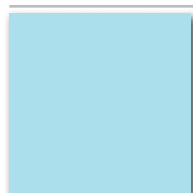



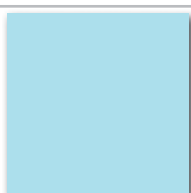





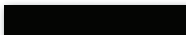

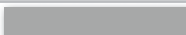
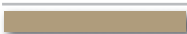

RAL 2408015

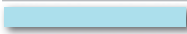

RAL 2408015

* 10% podíl výrobků s přeglazovanou hranou | 10% pieces with overglazed edges | 10% sztuk z przeszklwionymi krawędziami | 10% доля изделий с глазурованной боковой поверхностью

	Katalogové číslo Catalog number Numer katalogowy Артикул	Rozměr Barva Povrch Size Colour Surface Wymiar Kolor Powierzchnia Размер Цвет Поверхность	Cenová skupina Price group Grupa cenowa Ценовая группа	m ²	Karton Carton Karton Коробка	Paleta Pallet Paleta Поддон
					m ²	m ²
				kg	kg	kg
				Ks Pcs. Szt. Шт.	Ks Pcs. Szt. Шт.	Karton Carton Karton Коробка
 RAL 0001500  RAL 0001500	WLADD779	19,8 x 1,2 x 0,65 cm RAL 0001500 lesk glossy błyszcząca глянцевый	28 ks	-	-	-
	WLADG779	19,8 x 2,5 x 0,65 cm RAL 0001500 lesk glossy błyszcząca глянцевый	32 ks	-	1,0	-
 RAL 0007000  RAL 0007000	WLADD046	19,8 x 1,2 x 0,65 cm RAL 0007000 lesk glossy błyszcząca глянцевый	28 ks	-	-	-
	WLADG046	19,8 x 2,5 x 0,65 cm RAL 0007000 lesk glossy błyszcząca глянцевый	32 ks	-	1,0	-
 RAL 0757030  RAL 0757030	WLADD236	19,8 x 1,2 x 0,65 cm RAL 0757030 lesk glossy błyszcząca глянцевый	28 ks	-	-	-
	WLADG236	19,8 x 2,5 x 0,65 cm RAL 0757030 lesk glossy błyszcząca глянцевый	32 ks	-	1,0	-
 RAL 0304060  RAL 0304060	WLADD363	19,8 x 1,2 x 0,65 cm RAL 0304060 lesk glossy błyszcząca глянцевый	28 ks	-	-	-
	WLADG363	19,8 x 2,5 x 0,65 cm RAL 0304060 lesk glossy błyszcząca глянцевый	32 ks	-	1,0	-
 RAL 1605015  RAL 1605015	WLADD443	19,8 x 1,2 x 0,65 cm RAL 1605015 lesk glossy błyszcząca глянцевый	28 ks	-	-	-
	WLADG443	19,8 x 2,5 x 0,65 cm RAL 1605015 lesk glossy błyszcząca глянцевый	32 ks	-	1,0	-
 RAL 2902035  RAL 2902035	WLADD555	19,8 x 1,2 x 0,65 cm RAL 2902035 lesk glossy błyszcząca глянцевый	28 ks	-	-	-
	WLADG555	19,8 x 2,5 x 0,65 cm RAL 2902035 lesk glossy błyszcząca глянцевый	32 ks	-	1,0	-
 RAL 2408015  RAL 2408015	WLADD550	19,8 x 1,2 x 0,65 cm RAL 2408015 lesk glossy błyszcząca глянцевый	28 ks	-	-	-
	WLADG550	19,8 x 2,5 x 0,65 cm RAL 2408015 lesk glossy błyszcząca глянцевый	32 ks	-	1,0	-



CZ

GB

PL

RUS

Komplexní řešení

Glazované hutné dlaždice určené pro použití na podlahu i stěnu v modulových formátech od 23 x 23 mm až po 297 x 297 mm.

Modulové a barevně rozmanité kombinace s obkládačkami ColorONE umožňují vytvářet nejrůznější nadčasová řešení. Velmi dobře čitelné protiskluzné povrchy a široká nabídka tvarovek splňují i náročné požadavky na bezbariérové bydlení.

A complex solution

Glazed ceramic floor tiles designed for use both for floor and wall in modular formats from 23 x 23 mm up to 297 x 297 mm.

Modular and various colour combinations with ColorONE enables the creation of many and varied solutions. Highly visible slip-resistant surfaces with a wide choice of shaped pieces meet the very highest requirements in openplan housing.

Kompleksowe rozwiązanie

Szkliona terakota spieczona s przeznaczeniem na posadzki i ściany o rozmiarach modularnych od 23 x 23 mm do 297 x 297 mm.















Modularne i kolorystycznie rozmaite kombinacje z płytkami ściennymi ColorONE umożliwiają stworzyć różne ponadczasowe rozwiązania. Bardzo dobrze czyszczące przeciwpoślizgowe powierzchnie oraz szeroka oferta kształtek spełniają wysokie wymagania do bezbarierowych pomieszczeń.

Комплексное решение проектов

Глазурованная напольная керамическая плитка, производящаяся в модулярных размерах от 23 x 23 мм до 297 x 297 мм, может быть использована для облицовки пола и стен.

Разнообразные модулярные и цветовые комбинации с дополнительным использованием настенной плитки ColorONE позволяют осуществить самые неординарные архитектурные решения.





Простота в уходе за плиткой с противоскользкой поверхностью и широкий выбор фасонных элементов являются дополнительным фактором для удовлетворения требований по безопасной отделке помещений.

ČSN EN 14411 annex H Blb GL	Povrch Surface Powierzchnia Поверхность	Protiskluznost Slip resistance Przeciwpoślizgowość Противоскользющее свойство	WHITE	0001500	0004000	0007000	0008500	0757030	0808020	0809005	0808060	
	2,3x2,3x0,6	mat matt matowa матовый	R10 B	GDM02023 ○ 92 m²		GDM02046 ○ 94 m²	GDM02035 ○ 92 m²			GDM02032 ○ 92 m²		
		lesk glossy błyszcząca гляцевый		GDM02052 ○ 92 m²	GDM02548 ○ 94 m²							
	4,7x4,7x0,6	mat matt matowa матовый	R10 A	GDM05023 ○ 92 m²		GDM05046 ○ 94 m²	GDM05035 ○ 92 m²			GDM05032 ○ 92 m²		
		lesk glossy błyszcząca гляцевый		GDM05052 ○ 92 m²	GDM05548 ○ 94 m²							
		mat matt matowa матовый	R10 B	GRS05623 ○ 96 m²		GRS05646 ○ 98 m²	GRS05635 ○ 96 m²			GRS05632 ○ 96 m²		
	9,7x9,7x0,6	mat matt matowa матовый		GAA0K023 ○ 74 m²	GAA0K048 ○ 80 m²	GAA0K248 ○ 80 m²	GAA0K046 ○ 78 m²	GAA0K035 ○ 76 m²	GAA0K240 ○ 80 m²	GAA0K222 ○ 78 m²	GAA0K032 ○ 76 m²	GAA0K142 ○ 80 m²
		lesk glossy błyszcząca гляцевый		GAA0K052 ○ 74 m²	GAA0K548 ○ 80 m²							
		mat matt matowa матовый	R10 B	GRS0K623 ○ 76 m²		GRS0K248 ○ 82 m²	GRS0K646 ○ 80 m²	GRS0K635 ○ 78 m²			GRS0K632 ○ 78 m²	
	9,7x19,7x0,65	mat matt matowa матовый		GAAD8023 ○ 74 m²			GAAD8046 ○ 78 m²	GAAD8035 ○ 76 m²			GAAD8032 ○ 76 m²	
	14,7x14,7x0,65	mat matt matowa матовый		GAA17023 ○ 74 m²		GAA17248 ○ 80 m²	GAA17046 ○ 78 m²	GAA17035 ○ 76 m²				
		mat matt matowa матовый	R10 B	GRS17623 ○ 76 m²		GRS17248 ○ 82 m²	GRS17646 ○ 80 m²	GRS17635 ○ 78 m²				
	19,7x19,7x0,65	mat matt matowa матовый		GAA1K023 ○ 72 m²	GAA1K048 ○ 78 m²	GAA1K248 ○ 78 m²	GAA1K046 ○ 76 m²	GAA1K035 ○ 74 m²		GAA1K222 ○ 76 m²	GAA1K032 ○ 74 m²	GAA1K142 ○ 78 m²
		mat matt matowa матовый	R10 B	GRS1K623 ○ 74 m²		GRS1K248 ○ 80 m²	GRS1K646 ○ 78 m²	GRS1K635 ○ 76 m²			GRS1K632 ○ 76 m²	
	29,7x29,7x0,8	mat matt matowa матовый		GAA2J023 ○ 74 m²			GAA2J046 ○ 78 m²	GAA2J035 ○ 76 m²			GAA2J032 ○ 76 m²	
	9,7x9,7x0,6 bezbarierová tvarovka rohová shower piece - corner	mat matt matowa матовый	R10 B	GTRON623 ○ 52 ks		GTRON248 ○ 52 ks	GTRON646 ○ 52 ks				GTRON632 ○ 52 ks	
	9,7x9,7x0,6 bezbarierová tvarovka průběžná shower piece - continuous	mat matt matowa матовый	R10 B	GTPON623 ○ 52 ks		GTPON248 ○ 52 ks	GTPON646 ○ 52 ks				GTPON632 ○ 52 ks	
	9,7x10,3 sokl s pozáblbkem cove skirting	mat matt matowa матовый		GSP0J023 ○ 32 ks		GSP0J248 ○ 32 ks	GSP0J046 ○ 32 ks				GSP0J032 ○ 32 ks	
		mat matt matowa матовый	R10 B	GSTON623 ○ 36 ks		GSTON248 ○ 36 ks	GSTON646 ○ 36 ks				GSTON632 ○ 36 ks	
	3,0x10,3 sokl vnitřní roh skirting inside corner	mat matt matowa матовый		GSIRC023 ○ 48 ks		GSIRC248 ○ 48 ks	GSIRC046 ○ 48 ks				GSIRC032 ○ 48 ks	
	3,0x10,3 sokl vnější roh skirting outside corner	mat matt matowa матовый		GSERC023 ○ 48 ks		GSERC248 ○ 48 ks	GSERC046 ○ 48 ks				GSERC032 ○ 48 ks	
	2,4x9,7 průběžná hrana vnitřní shower piece - inside edge	mat matt matowa матовый		GSIA5023 ○ 48 ks		GSIA5248 ○ 48 ks	GSIA5046 ○ 48 ks				GSIA5032 ○ 48 ks	
	2,4x9,7 průběžná hrana vnější shower piece - outside edge	mat matt matowa матовый		GSEA5023 ○ 48 ks		GSEA5248 ○ 48 ks	GSEA5046 ○ 48 ks				GSEA5032 ○ 48 ks	
	2,4x2,4x2,4 vnější roh outside corner	mat matt matowa матовый		GTVR4023 ○ 56 ks		GTVR4248 ○ 56 ks	GTVR4046 ○ 56 ks				GTVR4032 ○ 56 ks	

0908040	1009010	0607050	0608040	0709020	0304060	0307030	0308010	1605015	1507030	1509010	2902035	2606025	2408015
								GDM02144 ○ 94 m²			GDM02005 ○ 94 m²		GDM02003 ○ 92 m²
								GDM05144 ○ 94 m²			GDM05005 ○ 94 m²		GDM05003 ○ 92 m²
								GRS05644 ○ 98 m²			GRS05605 ○ 98 m²		GRS05603 ○ 96 m²
GAA0K124 ○ 78 m²	GAA0K224 ○ 76 m²	GAA0K150 ○ 80 m²	GAA0K120 ○ 78 m²	GAA0K230 ○ 76 m²	GAA0K459 ○ 92 m²	GAA0K125 ○ 78 m²	GAA0K302 ○ 76 m²	GAA0K544 ○ 80 m²	GAA0K126 ○ 78 m²	GAA0K226 ○ 76 m²	GAA0K555 ○ 80 m²	GAA0K127 ○ 78 m²	GAA0K003 ○ 76 m²
					GAA0K359 ○ 92 m²								
								GRS0K644 ○ 82 m²			GRS0K605 ○ 82 m²		GRS0K603 ○ 78 m²
								GAAD8144 ○ 80 m²			GAAD8005 ○ 80 m²		GAAD8003 ○ 76 m²
								GAA17144 ○ 80 m²			GAA17005 ○ 80 m²		GAA17003 ○ 76 m²
								GRS17644 ○ 82 m²			GRS17605 ○ 82 m²		GRS17603 ○ 78 m²
GAA1K124 ○ 76 m²		GAA1K150 ○ 78 m²	GAA1K120 ○ 76 m²		GAA1K459 ○ 86 m²	GAA1K125 ○ 76 m²		GAA1K144 ○ 78 m²	GAA1K126 ○ 76 m²		GAA1K555 ○ 78 m²	GAA1K127 ○ 76 m²	GAA1K003 ○ 74 m²
								GRS1K644 ○ 80 m²			GRS1K605 ○ 80 m²		GRS1K603 ○ 76 m²
											GTR0N605 ○ 52 ks		
											GTP0N605 ○ 52 ks		
								GSP0J144 ○ 32 ks			GSP0J005 ○ 32 ks		GSP0J003 ○ 32 ks
											GST0N605 ○ 36 ks		
								GSIRC144 ○ 48 ks			GSIRC005 ○ 48 ks		GSIRC003 ○ 48 ks
								GSERC144 ○ 48 ks			GSERC005 ○ 48 ks		GSERC003 ○ 48 ks
								GSIA5144 ○ 48 ks			GSIA5005 ○ 48 ks		GSIA5003 ○ 48 ks
								GSEA5144 ○ 48 ks			GSEA5005 ○ 48 ks		GSEA5003 ○ 48 ks
								GTVR4144 ○ 56 ks			GTVR4005 ○ 56 ks		GTVR4003 ○ 56 ks

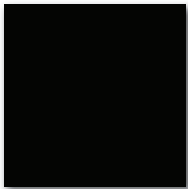
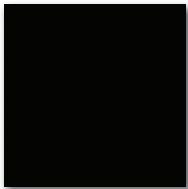
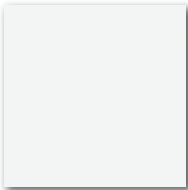
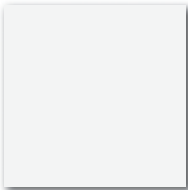
Barevné odstíny a RAL kódy, které jsou zde vyobrazeny, mají pouze orientační charakter. | The shown shades of the tiles and RAL design are only to the orientation. | Prezentowane kolory płytek a RAL kody są orientacyjne. | Цзображенні відтінки кольорів а RAL коди мають лише орієнтаційний характер.

RAL kód | RAL Design | RAL kod | RAL код

Katalogové číslo Catalog number Numer katalogowy Артикул	Rozměr Barva Povrch Size Colour Surface Wymiar Kolor Powierzchnia Размер Цвет Поверхность	Cenová skupina Price group Grupa cenowa Ценовая группа	m ²	Karton Carton Karton Коробка	Paleta Pallet Paleta Поддон		
				m ²	m ²		
			kg	kg	kg		
Ks Pcs. Szt. Шт.	Ks Pcs. Szt. Шт.	Karton Carton Karton Коробка					
 <p>RAL 0001500 PEI 2</p>  <p>RAL 0001500 PEI 2</p>	GDM02548	2,3 x 2,3 x 0,6 cm RAL 0001500 lesk glossy błyszcząca глянцевый	94 m ²	– 12,9 11	1,00 12,9 11	60,00 774 60	
	GDM05548	4,7 x 4,7 x 0,6 cm RAL 0001500 lesk glossy błyszcząca глянцевый	94 m ²	– 12,9 11	1,00 12,9 11	60,00 774 60	
	GAA0K048	9,7 x 9,7 x 0,6 cm RAL 0001500 mat matt matowa матовый	80 m ²	– 12,9 11	1,00 12,9 11	60,00 774 60	
	GAA0K548	9,7 x 9,7 x 0,6 cm RAL 0001500 lesk glossy błyszcząca глянцевый	80 m ²	– 12,9 11	1,00 12,9 11	60,00 774 60	
	GAA1K048	19,7 x 19,7 x 0,65 cm RAL 0001500 mat matt matowa матовый	78 m ²	– 14,2 25	1,00 14,2 25	80,00 1.162 80	
	 <p>WHITE PEI 4</p>  <p>WHITE PEI 2</p>  <p>WHITE (GRSxxxxx) PEI 4  </p>	GDM02023	2,3 x 2,3 x 0,6 cm WHITE R10B	92 m ²	– 12,9 11	1,00 12,9 11	60,00 774 60
		GDM02052	2,3 x 2,3 x 0,6 cm WHITE lesk glossy błyszcząca глянцевый	92 m ²	– 12,9 11	1,00 12,9 11	60,00 774 60
		GDM05023	4,7 x 4,7 x 0,6 cm WHITE R10A	92 m ²	– 12,9 11	1,00 12,9 11	60,00 774 60
		GDM05052	4,7 x 4,7 x 0,6 cm WHITE lesk glossy błyszcząca глянцевый	92 m ²	– 12,9 11	1,00 12,9 11	60,00 774 60
		GRS05623	4,7 x 4,7 x 0,6 cm WHITE R10B	96 m ²	– 12,9 11	1,00 12,9 11	60,00 774 60
		GAA0K023	9,7 x 9,7 x 0,6 cm WHITE mat matt matowa матовый	74 m ²	– 12,9 11	1,00 12,9 11	60,00 774 60
		GAA0K052	9,7 x 9,7 x 0,6 cm WHITE lesk glossy błyszcząca глянцевый	74 m ²	– 12,9 11	1,00 12,9 11	60,00 774 60
GRS0K623		9,7 x 9,7 x 0,6 cm WHITE R10B	76 m ²	– 12,9 11	1,00 12,9 11	60,00 774 60	
GAAD8023		9,7 x 19,7 x 0,65 cm WHITE mat matt matowa матовый	74 m ²	– 15,0 50	0,70 10,7 35	63,00 984 90	

Katalogové číslo Catalog number Numer katalogowy Артикул	Rozměr Barva Povrch Size Colour Surface Wymiar Kolor Powierzchnia Размер Цвет Поверхность	Cenová skupina Price group Grupa cenowa Ценовая группа	m ²	Karton Carton Karton Коробка	Paleta Pallet Paleta Поддон
				m ²	m ²
			kg	kg	kg
			Ks Pcs. Szt. Шт.	Ks Pcs. Szt. Шт.	Karton Carton Karton Коробка
GAA17023	14,7 x 14,7 x 0,65 cm WHITE mat matt matova матовый	74 m ²	–	1,00	80,00
			13,2	13,2	1.082
			44	44	80
GRS17623	14,7 x 14,7 x 0,65 cm WHITE R10 B	76 m ²	–	1,00	80,00
			13,2	13,2	1.082
			44	44	80
GAA1K023	19,7 x 19,7 x 0,65 cm WHITE mat matt matova матовый	72 m ²	–	1,00	80,00
			14,2	14,2	1.162
			25	25	80
GRS1K623	19,7 x 19,7 x 0,65 cm WHITE R10 B	74 m ²	–	1,00	80,00
			14,2	14,2	1.162
			25	25	80
GAA2J023	29,7 x 29,7 x 0,8 cm WHITE mat matt matova матовый	74 m ²	–	1,00	64,00
			18,0	18,0	1.179
			11	11	64
GAA0K248	9,7 x 9,7 x 0,6 cm RAL 0004000 mat matt matova матовый	80 m ²	–	1,00	60,00
			12,9	12,9	774
			11	11	60
GRS0K248	9,7 x 9,7 x 0,6 cm RAL 0004000 R10 B	82 m ²	–	1,00	60,00
			12,9	12,9	774
			11	11	60
GAA17248	14,7 x 14,7 x 0,65 cm RAL 0004000 mat matt matova матовый	80 m ²	–	1,00	80,00
			13,2	13,2	1.082
			44	44	80
GRS17248	14,7 x 14,7 x 0,65 cm RAL 0004000 R10 B	82 m ²	–	1,00	80,00
			13,2	13,2	1.082
			44	44	80
GAA1K248	19,7 x 19,7 x 0,65 cm RAL 0004000 mat matt matova матовый	78 m ²	–	1,00	80,00
			14,2	14,2	1.162
			25	25	80
GRS1K248	19,7 x 19,7 x 0,65 cm RAL 0004000 R10 B	80 m ²	–	1,00	80,00
			14,2	14,2	1.162
			25	25	80



RAL 0004000

PEI 2

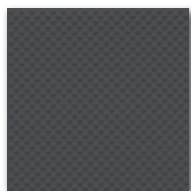

RAL 0004000
(GRSxxxxx)

PEI 2 R10 B

Katalogové číslo Catalog number Numer katalogowy Артикул	Rozměr Barva Povrch Size Colour Surface Wymiar Kolor Powierzchnia Размер Цвет Поверхность	Cenová skupina Price group Grupa cenowa Ценовая группа	m ²	Karton Carton Karton Коробка	Paleta Pallet Paleta Поддон
				m ²	m ²
			kg	kg	kg
			Ks Pcs. Szt. Шт.	Ks Pcs. Szt. Шт.	Karton Carton Karton Коробка

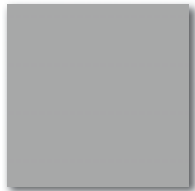

RAL 0007000
PEI 4



RAL 0007000
(GRSxxxxx)
PEI 4  

GDM02046	2,3 x 2,3 x 0,6 cm RAL 0007000 R10B	94 m ²	–	1,00	60,00
			12,9	12,9	774
			11	11	60
GDM05046	4,7 x 4,7 x 0,6 cm RAL 0007000 R10A	94 m ²	–	1,00	60,00
			12,9	12,9	774
			11	11	60
GRS05646	4,7 x 4,7 x 0,6 cm RAL 0007000 R10B	98 m ²	–	1,00	60,00
			12,9	12,9	774
			11	11	60
GAA0K046	9,7 x 9,7 x 0,6 cm RAL 0007000 R10A	78 m ²	–	1,00	60,00
			12,9	12,9	774
			11	11	60
GRS0K646	9,7 x 9,7 x 0,6 cm RAL 0007000 R10B	80 m ²	–	1,00	60,00
			12,9	12,9	774
			11	11	60
GAAD8046	9,7 x 19,7 x 0,65 cm RAL 0007000 mat matt matova матовый	78 m ²	–	0,70	63,00
			15,0	10,7	984
			50	35	90
GAA17046	14,7 x 14,7 x 0,65 cm RAL 0007000 mat matt matova матовый	78 m ²	–	1,00	80,00
			13,2	13,2	1.082
			44	44	80
GRS17646	14,7 x 14,7 x 0,65 cm RAL 0007000 R10B	80 m ²	–	1,00	80,00
			13,2	13,2	1.082
			44	44	80
GAA1K046	19,7 x 19,7 x 0,65 cm RAL 0007000 mat matt matova матовый	76 m ²	–	1,00	80,00
			14,2	14,2	1.162
			25	25	80
GRS1K646	19,7 x 19,7 x 0,65 cm RAL 0007000 R10B	78 m ²	–	1,00	80,00
			14,2	14,2	1.162
			25	25	80
GAA2J046	29,7 x 29,7 x 0,8 cm RAL 0007000 mat matt matova матовый	78 m ²	–	1,00	64,00
			18,0	18,0	1.179
			11	11	64

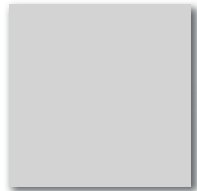

RAL 0008500

PEI 4



RAL 0008500
(GRSxxxxx)

PEI 4 R10 B

Katalogové číslo Catalog number Numer katalogowy Артикул	Rozměr Barva Povrch Size Colour Surface Wymiar Kolor Powierzchnia Размер Цвет Поверхность	Cenová skupina Price group Grupa cenowa Ценовая группа	m ²	Karton Carton Karton Коробка	Paleta Pallet Paleta Поддон
				m ²	m ²
			kg	kg	kg
			Ks Pcs. Szt. Шт.	Ks Pcs. Szt. Шт.	Karton Carton Karton Коробка
GDM02035	2,3 x 2,3 x 0,6 cm RAL 0008500 R10B	92 m ²	–	1,00	60,00
			12,9	12,9	774
			11	11	60
GDM05035	4,7 x 4,7 x 0,6 cm RAL 0008500 R10A	92 m ²	–	1,00	60,00
			12,9	12,9	774
			11	11	60
GRS05635	4,7 x 4,7 x 0,6 cm RAL 0008500 R10B	96 m ²	–	1,00	60,00
			12,9	12,9	774
			11	11	60
GAA0K035	9,7 x 9,7 x 0,6 cm RAL 0008500 mat matt matova матовый	76 m ²	–	1,00	60,00
			12,9	12,9	774
			11	11	60
GRS0K635	9,7 x 9,7 x 0,6 cm RAL 0008500 R10B	78 m ²	–	1,00	60,00
			12,9	12,9	774
			11	11	60
GAAD8035	9,7 x 19,7 x 0,65 cm RAL 0008500 mat matt matova матовый	76 m ²	–	0,70	63,00
			15,0	10,7	984
			50	35	90
GAA17035	14,7 x 14,7 x 0,65 cm RAL 0008500 mat matt matova матовый	76 m ²	–	1,00	80,00
			13,2	13,2	1.082
			44	44	80
GRS17635	14,7 x 14,7 x 0,65 cm RAL 0008500 R10B	78 m ²	–	1,00	80,00
			13,2	13,2	1.082
			44	44	80
GAA1K035	19,7 x 19,7 x 0,65 cm RAL 0008500 mat matt matova матовый	74 m ²	–	1,00	80,00
			14,2	14,2	1.162
			25	25	80
GRS1K635	19,7 x 19,7 x 0,65 cm RAL 0008500 R10B	76 m ²	–	1,00	80,00
			14,2	14,2	1.162
			25	25	80
GAA2J035	29,7 x 29,7 x 0,8 cm RAL 0008500 mat matt matova матовый	76 m ²	–	1,00	64,00
			18,0	18,0	1.179
			11	11	64

Katalogové číslo Catalog number Numer katalogowy Артикул	Rozměr Barva Povrch Size Colour Surface Wymiar Kolor Powierzchnia Размер Цвет Поверхность	Cenová skupina Price group Grupa cenowa Ценовая группа	m ²	Karton Carton Karton Коробка	Paleta Pallet Paleta Поддон
				m ²	m ²
			kg	kg	kg
			Ks Pcs. Szt. Шт.	Ks Pcs. Szt. Шт.	Karton Carton Karton Коробка

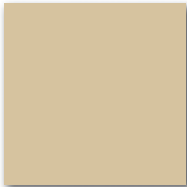
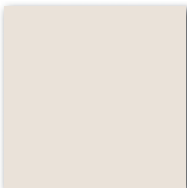
 RAL 0757030 PEI 3	GAA0K240	9,7 x 9,7 x 0,6 cm RAL 0757030 mat matt matova матовый	80 m ²	– 12,9 11	1,00 12,9 11	60,00 774 60	
	 RAL 0808020 PEI 3	GAA0K222	9,7 x 9,7 x 0,6 cm RAL 0808020 mat matt matova матовый	78 m ²	– 12,9 11	1,00 12,9 11	60,00 774 60
		GAA1K222	19,7 x 19,7 x 0,65 cm RAL 0808020 mat matt matova матовый	76 m ²	– 14,2 25	1,00 14,2 25	80,00 1.162 80
 RAL 0809005 PEI 4	GDM02032	2,3 x 2,3 x 0,6 cm RAL 0809005 R10 B	92 m ²	– 12,9 11	1,00 12,9 11	60,00 774 60	
				GDM05032	4,7 x 4,7 x 0,6 cm RAL 0809005 R10 A	92 m ²	– 12,9 11
	GRS05632	4,7 x 4,7 x 0,6 cm RAL 0809005 R10 B	96 m ²				– 12,9 11
				GAA0K032	9,7 x 9,7 x 0,6 cm RAL 0809005 mat matt matova матовый	76 m ²	– 12,9 11
	GRS0K632	9,7 x 9,7 x 0,6 cm RAL 0809005 R10 B	78 m ²				– 12,9 11
				GAAD8032	9,7 x 19,7 x 0,65 cm RAL 0809005 mat matt matova матовый	76 m ²	– 15,0 50

Katalogové číslo Catalog number Numer katalogowy Артикул	Rozměr Barva Povrch Size Colour Surface Wymiar Kolor Powierzchnia Размер Цвет Поверхность	Cenová skupina Price group Grupa cenowa Ценовая группа	m ²	Karton Carton Karton Коробка	Paleta Pallet Paleta Поддон	
				m ²	m ²	
			kg	kg	kg	
			Ks Pcs. Szt. Шт.	Ks Pcs. Szt. Шт.	Karton Carton Karton Коробка	
GAA1K032	19,7 x 19,7 x 0,65 cm RAL 0809005 mat matt matova матовый	74 m ²	–	1,00	80,00	
			14,2	14,2	1.162	
			25	25	80	
	GRS1K632	19,7 x 19,7 x 0,65 cm RAL 0809005 R10 B	76 m ²	–	1,00	80,00
				14,2	14,2	1.162
				25	25	80
GAA2J032	29,7 x 29,7 x 0,8 cm RAL 0809005 mat matt matova матовый	76 m ²	–	1,00	64,00	
			18,0	18,0	1.179	
			11	11	64	
GAA0K142	9,7 x 9,7 x 0,6 cm RAL 0808060 mat matt matova матовый	80 m ²	–	1,00	60,00	
			12,9	12,9	774	
			11	11	60	
	GAA1K142	19,7 x 19,7 x 0,65 cm RAL 0808060 mat matt matova матовый	78 m ²	–	1,00	80,00
				14,2	14,2	1.162
				25	25	80
GAA0K124	9,7 x 9,7 x 0,6 cm RAL 0908040 mat matt matova матовый	78 m ²	–	1,00	60,00	
			12,9	12,9	774	
			11	11	60	
	GAA1K124	19,7 x 19,7 x 0,65 cm RAL 0908040 mat matt matova матовый	76 m ²	–	1,00	80,00
				14,2	14,2	1.162
				25	25	80
GAA0K224	9,7 x 9,7 x 0,6 cm RAL 1009010 mat matt matova матовый	76 m ²	–	1,00	60,00	
			12,9	12,9	774	
			11	11	60	
GAA0K150	9,7 x 9,7 x 0,6 cm RAL 0607050 mat matt matova матовый	80 m ²	–	1,00	60,00	
			12,9	12,9	774	
			11	11	60	
	GAA1K150	19,7 x 19,7 x 0,65 cm RAL 0607050 mat matt matova матовый	78 m ²	–	1,00	80,00
				14,2	14,2	1.162
				25	25	80

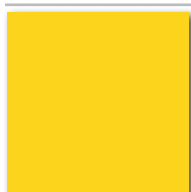

RAL 0808060

PEI 3

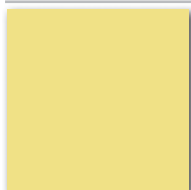

RAL 0908040

PEI 4

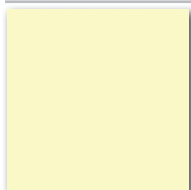

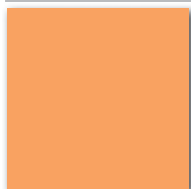

RAL 1009010

PEI 4

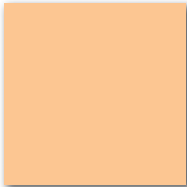
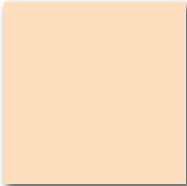

RAL 0607050

PEI 3

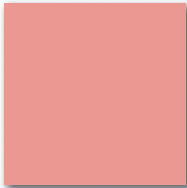
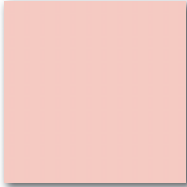
Katalogové číslo Catalog number Numer katalogowy Артикул	Rozměr Barva Povrch Size Colour Surface Wymiar Kolor Powierzchnia Размер Цвет Поверхность	Cenová skupina Price group Grupa cenowa Ценовая группа	m ²	Karton Carton Karton Коробка	Paleta Pallet Paleta Поддон	
				m ²	m ²	
			kg	kg	kg	
			Ks Pcs. Szt. Шт.	Ks Pcs. Szt. Шт.	Karton Carton Karton Коробка	
 RAL 0608040 PEI 4	GAA0K120 9,7 x 9,7 x 0,6 cm RAL 0608040 mat matt matova матовый	78 m ²	–	1,00	60,00	
			12,9	12,9	774	
			11	11	60	
	GAA1K120 19,7 x 19,7 x 0,65 cm RAL 0608040 mat matt matova матовый	76 m ²	–	1,00	80,00	
			14,2	14,2	1.162	
			25	25	80	
 RAL 0709020 PEI 4	GAA0K230 9,7 x 9,7 x 0,6 cm RAL 0709020 mat matt matova матовый	76 m ²	–	1,00	60,00	
			12,9	12,9	774	
			11	11	60	
	 RAL 0304060 PEI 2	GAA0K459 9,7 x 9,7 x 0,6 cm RAL 0304060 mat matt matova матовый	92 m ²	–	1,00	60,00
				12,9	12,9	774
				11	11	60
GAA0K359 9,7 x 9,7 x 0,6 cm RAL 0304060 lesk glossy błyszcząca глянцевый		92 m ²	–	1,00	60,00	
			12,9	12,9	774	
			11	11	60	
 RAL 0307030 PEI 4	GAA1K459 19,7 x 19,7 x 0,65 cm RAL 0304060 mat matt matova матовый	86 m ²	–	1,00	80,00	
			14,2	14,2	1.162	
			25	25	80	
	GAA0K125 9,7 x 9,7 x 0,6 cm RAL 0307030 mat matt matova матовый	78 m ²	–	1,00	60,00	
			12,9	12,9	774	
			11	11	60	
GAA1K125 19,7 x 19,7 x 0,65 cm RAL 0307030 mat matt matova матовый	76 m ²	–	1,00	80,00		
		14,2	14,2	1.162		
		25	25	80		
 RAL 0308010 PEI 4	GAA0K302 9,7 x 9,7 x 0,6 cm RAL 0308010 mat matt matova матовый	76 m ²	–	1,00	60,00	
			12,9	12,9	774	
			11	11	60	

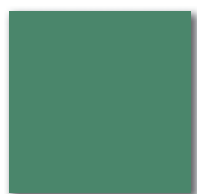

RAL 1605015

PEI 3

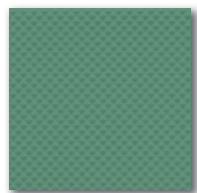
RAL 1605015
(GRSxxxxx)

PEI 3 R10 B

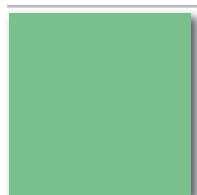

RAL 1507030

PEI 4



RAL 1509010

PEI 4

Katalogové číslo Catalog number Numer katalogowy Артикул	Rozměr Barva Povrch Size Colour Surface Wymiar Kolor Powierzchnia Размер Цвет Поверхность	Cenová skupina Price group Grupa cenowa Ценовая группа	m ²	Karton Carton Karton Коробка	Paleta Pallet Paleta Поддон
				m ²	m ²
			kg	kg	kg
Ks Pcs. Szt. Шт.	Ks Pcs. Szt. Шт.	Karton Carton Karton Коробка			
GDM02144	2,3 x 2,3 x 0,6 cm RAL 1605015 R10B	94 m ²	–	1,00	60,00
			12,9	12,9	774
			11	11	60
GDM05144	4,7 x 4,7 x 0,6 cm RAL 1605015 R10A	94 m ²	–	1,00	60,00
			12,9	12,9	774
			11	11	60
GRS05644	4,7 x 4,7 x 0,6 cm RAL 1605015 R10B	98 m ²	–	1,00	60,00
			12,9	12,9	774
			11	11	60
GAA0K544	9,7 x 9,7 x 0,6 cm RAL 1605015 mat matt matova матовый	80 m ²	–	1,00	60,00
			12,9	12,9	774
			11	11	60
GRS0K644	9,7 x 9,7 x 0,6 cm RAL 1605015 R10B	82 m ²	–	1,00	60,00
			12,9	12,9	774
			11	11	60
GAAD8144	9,7 x 19,7 x 0,65 cm RAL 1605015 mat matt matova матовый	80 m ²	–	0,70	63,00
			15,0	10,7	984
			50	35	90
GAA17144	14,7 x 14,7 x 0,65 cm RAL 1605015 mat matt matova матовый	80 m ²	–	1,00	80,00
			13,2	13,2	1.082
			44	44	80
GRS17644	14,7 x 14,7 x 0,65 cm RAL 1605015 R10B	82 m ²	–	1,00	80,00
			13,2	13,2	1.082
			44	44	80
GAA1K144	19,7 x 19,7 x 0,65 cm RAL 1605015 mat matt matova матовый	78 m ²	–	1,00	80,00
			14,2	14,2	1.162
			25	25	80
GRS1K644	19,7 x 19,7 x 0,65 cm RAL 1605015 R10B	80 m ²	–	1,00	80,00
			14,2	14,2	1.162
			25	25	80
GAA0K126	9,7 x 9,7 x 0,6 cm RAL 1507030 mat matt matova матовый	78 m ²	–	1,00	60,00
			12,9	12,9	774
			11	11	60
GAA1K126	19,7 x 19,7 x 0,65 cm RAL 1507030 mat matt matova матовый	76 m ²	–	1,00	80,00
			14,2	14,2	1.162
			25	25	80
GAA0K226	9,7 x 9,7 x 0,6 cm RAL 1509010 mat matt matova матовый	76 m ²	–	1,00	60,00
			12,9	12,9	774
			11	11	60

Katalogové číslo Catalog number Numer katalogowy Артикул	Rozměr Barva Povrch Size Colour Surface Wymiar Kolor Powierzchnia Размер Цвет Поверхность	Cenová skupina Price group Grupa cenowa Ценовая группа	m ²	Karton Carton Karton Коробка	Paleta Pallet Paleta Поддон
				m ²	m ²
			kg	kg	kg
			Ks Pcs. Szt. Шт.	Ks Pcs. Szt. Шт.	Karton Carton Karton Коробка

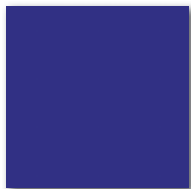

RAL 2902035

PEI 3



RAL 2902035
(GRSxxxxx)

PEI 3  

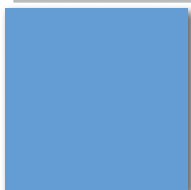

RAL 2606025

PEI 4

GDM02005	2,3 x 2,3 x 0,6 cm RAL 2902035 R10B	94 m ²	–	1,00	60,00
			12,9	12,9	774
			11	11	60
GDM05005	4,7 x 4,7 x 0,6 cm RAL 2902035 R10A	94 m ²	–	1,00	60,00
			12,9	12,9	774
			11	11	60
GRS05605	4,7 x 4,7 x 0,6 cm RAL 2902035 R10B	98 m ²	–	1,00	60,00
			12,9	12,9	774
			11	11	60
GAA0K555	9,7 x 9,7 x 0,6 cm RAL 2902035 mat matt matova матовый	80 m ²	–	1,00	60,00
			12,9	12,9	774
			11	11	60
GRS0K605	9,7 x 9,7 x 0,6 cm RAL 2902035 R10B	82 m ²	–	1,00	60,00
			12,9	12,9	774
			11	11	60
GAAD8005	9,7 x 19,7 x 0,65 cm RAL 2902035 mat matt matova матовый	80 m ²	–	0,70	63,00
			15,0	10,7	984
			50	35	90
GAA17005	14,7 x 14,7 x 0,65 cm RAL 2902035 mat matt matova матовый	80 m ²	–	1,00	80,00
			13,2	13,2	1.082
			44	44	80
GRS17605	14,7 x 14,7 x 0,65 cm RAL 2902035 R10B	82 m ²	–	1,00	80,00
			13,2	13,2	1.082
			44	44	80
GAA1K555	19,7 x 19,7 x 0,65 cm RAL 2902035 mat matt matova матовый	78 m ²	–	1,00	80,00
			14,2	14,2	1.162
			25	25	80
GRS1K605	19,7 x 19,7 x 0,65 cm RAL 2902035 R10B	80 m ²	–	1,00	80,00
			14,2	14,2	1.162
			25	25	80
GAA0K127	9,7 x 9,7 x 0,6 cm RAL 2606025 mat matt matova матовый	78 m ²	–	1,00	60,00
			12,9	12,9	774
			11	11	60
GAA1K127	19,7 x 19,7 x 0,65 cm RAL 2606025 mat matt matova матовый	76 m ²	–	1,00	80,00
			14,2	14,2	1.162
			25	25	80

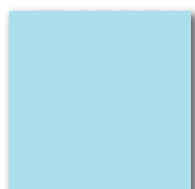

RAL 2408015











PEI 4





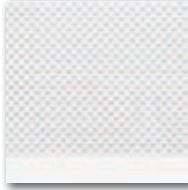





RAL 2408015
(GRSxxxxx)





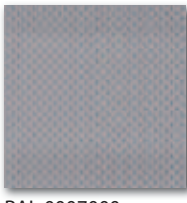

PEI 4 R10 B

Katalogové číslo Catalog number Numer katalogowy Артикул	Rozměr Barva Povrch Size Colour Surface Wymiar Kolor Powierzchnia Размер Цвет Поверхность	Cenová skupina Price group Grupa cenowa Ценовая группа	m ²	Karton Carton Karton Коробка	Paleta Pallet Paleta Поддон
				m ²	m ²
			kg	kg	kg
			Ks Pcs. Szt. Шт.	Ks Pcs. Szt. Шт.	Karton Carton Karton Коробка
GDM02003	2,3 x 2,3 x 0,6 cm RAL 2408015 R10B	92 m ²	–	1,00	60,00
			12,9	12,9	774
			11	11	60
GDM05003	4,7 x 4,7 x 0,6 cm RAL 2408015 R10A	92 m ²	–	1,00	60,00
			12,9	12,9	774
			11	11	60
GRS05603	4,7 x 4,7 x 0,6 cm RAL 2408015 R10B	96 m ²	–	1,00	60,00
			12,9	12,9	774
			11	11	60
GAA0K003	9,7 x 9,7 x 0,6 cm RAL 2408015 mat matt matova матовый	76 m ²	–	1,00	60,00
			12,9	12,9	774
			11	11	60
GRS0K603	9,7 x 9,7 x 0,6 cm RAL 2408015 R10B	78 m ²	–	1,00	60,00
			12,9	12,9	774
			11	11	60
GAAD8003	9,7 x 19,7 x 0,65 cm RAL 2408015 mat matt matova матовый	76 m ²	–	0,70	63,00
			15,0	10,7	984
			50	35	90
GAA17003	14,7 x 14,7 x 0,65 cm RAL 2408015 mat matt matova матовый	76 m ²	–	1,00	80,00
			13,2	13,2	1.082
			44	44	80
GRS17603	14,7 x 14,7 x 0,65 cm RAL 2408015 R10B	78 m ²	–	1,00	80,00
			13,2	13,2	1.082
			44	44	80
GAA1K003	19,7 x 19,7 x 0,65 cm RAL 2408015 mat matt matova матовый	74 m ²	–	1,00	80,00
			14,2	14,2	1.162
			25	25	80
GRS1K603	19,7 x 19,7 x 0,65 cm RAL 2408015 R10B	76 m ²	–	1,00	80,00
			14,2	14,2	1.162
			25	25	80

Katalogové číslo Catalog number Numer katalogowy Артикул	Rozměr Barva Povrch Size Colour Surface Wymiar Kolor Powierzchnia Размер Цвет Поверхность	Cenová skupina Price group Grupa cenowa Ценовая группа	m ²	Karton Carton Karton Коробка	Paleta Pallet Paleta Поддон	
				m ²	m ²	
			kg	kg	kg	
			Ks Pcs. Szt. Шт.	Ks Pcs. Szt. Шт.	Karton Carton Karton Коробка	
 WHITE PEI 4  R10 	GTRON623 9,7 x 9,7 x 0,6 cm WHITE R10B	52 ks	–	0,18	–	
			13,0	2,34	–	
			100	18	–	
 WHITE PEI 4  R10 	GTPON623 9,7 x 9,7 x 0,6 cm WHITE R10B	52 ks	–	0,18	–	
			13,0	2,34	–	
			100	18	–	
  WHITE PEI 4	GSP0J023 9,7 x 10,3 cm WHITE mat matt matova матовый	32 ks	–	0,90	–	
	GSTON623 9,7 x 10,3 cm WHITE R10B	36 ks	13,0	11,7	–	
			100	90	–	
	 WHITE	GSIRC023 3,0 x 10,3 cm WHITE mat matt matova матовый	48 ks	–	–	–
				–	10,4	–
				–	80	–
 WHITE	GSERC023 3,0 x 10,3 cm WHITE mat matt matova матовый	48 ks	–	–	–	
			–	10,4	–	
			–	80	–	
 WHITE	GSIA5023 2,4 x 9,7 cm WHITE mat matt matova матовый	48 ks	–	–	–	
			–	10,4	–	
			–	80	–	











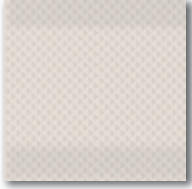

	Katalogové číslo Catalog number Numer katalogowy Артикул	Rozměr Barva Povrch Size Colour Surface Wymiar Kolor Powierzchnia Размер Цвет Поверхность	Cenová skupina Price group Grupa cenowa Ценовая группа	m ²	Karton Carton Karton Коробка	Paleta Pallet Paleta Поддон
					m ²	m ²
				kg	kg	kg
				Ks Pcs. Szt. Шт.	Ks Pcs. Szt. Шт.	Karton Carton Karton Коробка
 WHITE	GSEA5023	2,4 x 9,7 cm WHITE mat matt matova матовый	48 ks	- - -	- 10,4 80	- - -
 WHITE	GTVR4023	2,4 x 2,4 x 2,4 cm WHITE mat matt matova матовый	56 ks	- - -	- 6,5 50	- - -
 RAL 0004000 PEI 2  R10 	GTR0N248	9,7 x 9,7 x 0,6 cm RAL 0004000 R10 B	52 ks	- 13,0 100	0,18 2,34 18	- - -
 RAL 0004000 PEI 2  R10 	GTP0N248	9,7 x 9,7 x 0,6 cm RAL 0004000 R10 B	52 ks	- 13,0 100	0,18 2,34 18	- - -
 RAL 0004000 PEI 2	GSP0J248 GST0N248	9,7 x 10,3 cm RAL 0004000 mat matt matova матовый	32 ks	- 13,0 100	0,90 11,7 90	- - -
 RAL 0004000 PEI 2  R10 		9,7 x 10,3 cm RAL 0004000 R10 B	36 ks	- 13,0 100	0,90 11,7 90	- - -
 RAL 0004000		3,0 x 10,3 cm RAL 0004000 mat matt matova матовый	48 ks	- - -	- 10,4 80	- - -

Katalogové číslo Catalog number Numer katalogowy Артикул	Rozměr Barva Povrch Size Colour Surface Wymiar Kolor Powierzchnia Размер Цвет Поверхность	Cenová skupina Price group Grupa cenowa Ценовая группа	m ²	Karton Carton Karton Коробка	Paleta Pallet Paleta Поддон
				m ²	m ²
			kg	kg	kg
			Ks Pcs. Szt. Шт.	Ks Pcs. Szt. Шт.	Karton Carton Karton Коробка
 RAL 0004000	GSERC248 3,0 x 10,3 cm RAL 0004000 mat matt matova матовый	48 ks	-	-	-
			-	10,4	-
			-	80	-
 RAL 0004000	GSIA5248 2,4 x 9,7 cm RAL 0004000 mat matt matova матовый	48 ks	-	-	-
			-	10,4	-
			-	80	-
 RAL 0004000	GSEA5248 2,4 x 9,7 cm RAL 0004000 mat matt matova матовый	48 ks	-	-	-
			-	10,4	-
			-	80	-
 RAL 0004000	GTVR4248 2,4 x 2,4 x 2,4 cm RAL 0004000 mat matt matova матовый	56 ks	-	-	-
			-	6,5	-
			-	50	-
 RAL 0007000 PEI 4  R10  B	GTRON646 9,7 x 9,7 x 0,6 cm RAL 0007000 R10B	52 ks	-	0,18	-
			13,0	2,34	-
			100	18	-
 RAL 0007000 PEI 4  R10  B	GTPON646 9,7 x 9,7 x 0,6 cm RAL 0007000 R10B	52 ks	-	0,18	-
			13,0	2,34	-
			100	18	-

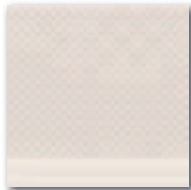
	Katalogové číslo Catalog number Numer katalogowy Артикул	Rozměr Barva Povrch Size Colour Surface Wymiar Kolor Powierzchnia Размер Цвет Поверхность	Cenová skupina Price group Grupa cenowa Ценовая группа	m ²	Karton Carton Коробка	Paleta Pallet Поддон	
					m ²	m ²	
				kg	kg	kg	
				Ks Pcs. Szt. Шт.	Ks Pcs. Szt. Шт.	Karton Carton Коробка	
 RAL 0007000 PEI 4	 RAL 0007000 PEI 4 R10 B	GSP0J046	9,7 x 10,3 cm	32 ks	–	0,90	–
		GST0N646	9,7 x 10,3 cm	36 ks	13,0	11,7	–
 RAL 0007000		GSIRC046	3,0 x 10,3 cm	48 ks	–	–	–
					–	10,4	–
 RAL 0007000		GSERC046	3,0 x 10,3 cm	48 ks	–	–	–
					–	10,4	–
 RAL 0007000		GSIA5046	2,4 x 9,7 cm	48 ks	–	–	–
					–	10,4	–
 RAL 0007000		GSEA5046	2,4 x 9,7 cm	48 ks	–	–	–
					–	10,4	–
 RAL 0007000		GTVR4046	2,4 x 2,4 x 2,4 cm	56 ks	–	–	–
					–	6,5	–
					–	50	–

Barevné odstíny a RAL kódy, které jsou zde vyobrazeny, mají pouze orientační charakter. | The shown shades of the tiles and RAL design are only to the orientation. | Prezentowane kolory płytek a RAL kody są orientacyjne. | Цзображенне оттенки цветов а RAL коды имеют лишь ориентационный характер.

RAL kód | RAL Design | RAL kod | RAL код













Katalogové číslo Catalog number Numer katalogowy Артикул	Rozměr Barva Povrch Size Colour Surface Wymiar Kolor Powierzchnia Размер Цвет Поверхность	Cenová skupina Price group Grupa cenowa Ценовая группа	m ²	Karton Carton Karton Коробка	Paleta Pallet Paleta Поддон	
				m ²	m ²	
			kg	kg	kg	
			Ks Pcs. Szt. Шт.	Ks Pcs. Szt. Шт.	Karton Carton Karton Коробка	
 RAL 0809005 PEI 4  R10  B	GTRON632 9,7 x 9,7 x 0,6 cm RAL 0809005 R10 B	52 ks	–	0,18	–	
			13,0	2,34	–	
			100	18	–	
 RAL 0809005 PEI 4  R10  B	GTPON632 9,7 x 9,7 x 0,6 cm RAL 0809005 R10 B	52 ks	–	0,18	–	
			13,0	2,34	–	
			100	18	–	
 RAL 0809005 PEI 4	GSP0J032 9,7 x 10,3 cm RAL 0809005 mat matt matova матовый	32 ks	–	0,90	–	
			13,0	11,7	–	
	 RAL 0809005 PEI 4  R10  B	GSTON632 9,7 x 10,3 cm RAL 0809005 R10 B	36 ks	100	90	–
				–	0,90	–
				13,0	11,7	–
				100	90	–
 RAL 0809005	GSIRC032 3,0 x 10,3 cm RAL 0809005 mat matt matova матовый	48 ks	–	–	–	
			–	10,4	–	
			–	80	–	
 RAL 0809005	GSERC032 3,0 x 10,3 cm RAL 0809005 mat matt matova матовый	48 ks	–	–	–	
			–	10,4	–	
			–	80	–	
 RAL 0809005	GSIA5032 2,4 x 9,7 cm RAL 0809005 mat matt matova матовый	48 ks	–	–	–	
			–	10,4	–	
			–	80	–	

ČSN EN 14411 annex H Blb GL

	Katalogové číslo Catalog number Numer katalogowy Артикул	Rozměr Barva Povrch Size Colour Surface Wymiar Kolor Powierzchnia Размер Цвет Поверхность	Cenová skupina Price group Grupa cenowa Ценовая группа	m ²	Karton Carton Karton Коробка	Paleta Pallet Paleta Поддон
					m ²	m ²
				kg	kg	kg
				Ks Pcs. Szt. Шт.	Ks Pcs. Szt. Шт.	Karton Carton Karton Коробка
 RAL 0809005	GSEA5032	2,4 x 9,7 cm RAL 0809005 mat matt matova матовый	48 ks	- - -	- 10,4 80	- - -
 RAL 0809005	GTVR4032	2,4 x 2,4 x 2,4 cm RAL 0809005 mat matt matova матовый	56 ks	- - -	- 6,5 50	- - -
 RAL 2902035 PEI 3	GSP0J144	9,7 x 10,3 cm RAL 1605015 mat matt matova матовый	32 ks	- 13,0 100	0,90 11,7 90	- - -
 RAL 1605015	GSIRC144	3,0 x 10,3 cm RAL 1605015 mat matt matova матовый	48 ks	- - -	- 10,4 80	- - -
 RAL 1605015	GSERC144	3,0 x 10,3 cm RAL 1605015 mat matt matova матовый	48 ks	- - -	- 10,4 80	- - -
 RAL 1605015	GSIA5144	2,4 x 9,7 cm RAL 1605015 mat matt matova матовый	48 ks	- - -	- 10,4 80	- - -
 RAL 1605015	GSEA5144	2,4 x 9,7 cm RAL 1605015 mat matt matova матовый	48 ks	- - -	- 10,4 80	- - -

Barevné odstíny a RAL kódy, které jsou zde vyobrazeny, mají pouze orientační charakter. | The shown shades of the tiles and RAL design are only to the orientation. | Prezentowane kolory płytek a RAL kody są orientacyjne. | Цзображенні відтінки цвeтoв a RAL кoдy мeють лiшь oрiєнтaцiйний хaрaктер.



RAL kód | RAL Design | RAL kod | RAL код

	Katalogové číslo Catalog number Numer katalogowy Артикул	Rozměr Barva Povrch Size Colour Surface Wymiar Kolor Powierzchnia Размер Цвет Поверхность	Cenová skupina Price group Grupa cenowa Ценовая группа	m ²	Karton Carton Karton Коробка	Paleta Pallet Paleta Поддон
					m ²	m ²
				kg	kg	kg
				Ks Pcs. Szt. Шт.	Ks Pcs. Szt. Шт.	Karton Carton Karton Коробка
 RAL 1605015	GTVR4144	2,4 x 2,4 x 2,4 cm RAL 1605015 mat matt matova матовый	56 ks	- - -	- 6,5 50	- - -
 RAL 2902035 PEI 3  R10  B	GTR0N605	9,7 x 9,7 x 0,6 cm RAL 2902035 R10 B	52 ks	- 13,0 100	0,18 2,34 18	- - -
 RAL 2902035 PEI 3  R10  B	GTP0N605	9,7 x 9,7 x 0,6 cm RAL 2902035 R10 B	52 ks	- 13,0 100	0,18 2,34 18	- - -
 RAL 2902035 PEI 3	GSP0J005	9,7 x 10,3 cm RAL 2902035 mat matt matova матовый	32 ks	- 13,0 100	0,90 11,7 90	- - -
 RAL 2902035 PEI 3  R10  B	GST0N605	9,7 x 10,3 cm RAL 2902035 R10 B	36 ks	- 13,0 100	0,90 11,7 90	- - -
 RAL 2902035	GSIRC005	3,0 x 10,3 cm RAL 2902035 mat matt matova матовый	48 ks	- - -	- 10,4 80	- - -
 RAL 2902035	GSERC005	3,0 x 10,3 cm RAL 2902035 mat matt matova матовый	48 ks	- - -	- 10,4 80	- - -

	Katalogové číslo Catalog number Numer katalogowy Артикул	Rozměr Barva Povrch Size Colour Surface Wymiar Kolor Powierzchnia Размер Цвет Поверхность	Cenová skupina Price group Grupa cenowa Ценовая группа	m ²	Karton Carton Коробка	Paleta Pallet Поддон
					m ²	m ²
				kg	kg	kg
				Ks Pcs. Szt. Шт.	Ks Pcs. Szt. Шт.	Karton Carton Коробка
 RAL 2902035	GSIA5005	2,4 x 9,7 cm RAL 2902035 mat matt matova матовый	48 ks	-	-	-
				-	10,4	-
				-	80	-
 RAL 2902035	GSEA5005	2,4 x 9,7 cm RAL 2902035 mat matt matova матовый	48 ks	-	-	-
				-	10,4	-
				-	80	-
 RAL 2902035	GTVR4005	2,4 x 2,4 x 2,4 cm RAL 2902035 mat matt matova матовый	56 ks	-	-	-
				-	6,5	-
				-	50	-
 RAL 2902035 PEI 4	GSP0J003	9,7 x 10,3 cm RAL 2408015 mat matt matova матовый	32 ks	-	0,90	-
				13,0	11,7	-
				100	90	-
 RAL 2408015	GSIRC003	3,0 x 10,3 cm RAL 2408015 mat matt matova матовый	48 ks	-	-	-
				-	10,4	-
				-	80	-
 RAL 2408015	GSERC003	3,0 x 10,3 cm RAL 2408015 mat matt matova матовый	48 ks	-	-	-
				-	10,4	-
				-	80	-

Katalogové číslo Catalog number Numer katalogowy Артикул	Rozměr Barva Povrch Size Colour Surface Wymiar Kolor Powierzchnia Размер Цвет Поверхность	Cenová skupina Price group Grupa cenowa Ценовая группа	m ²	Karton Carton Karton Коробка	Paleta Pallet Paleta Поддон
				m ²	m ²
			kg	kg	kg
			Ks Pcs. Szt. Шт.	Ks Pcs. Szt. Шт.	Karton Carton Karton Коробка

ČSN EN 14411 annex H Blb GL

 RAL 2408015	GSIA5003	2,4 x 9,7 cm RAL 2408015 mat matt matova матовый	48 ks	-	-	-
				-	10,4	-
				-	80	-
 RAL 2408015	GSEA5003	2,4 x 9,7 cm RAL 2408015 mat matt matova матовый	48 ks	-	-	-
				-	10,4	-
				-	80	-
 RAL 2408015	GTVR4003	2,4 x 2,4 x 2,4 cm RAL 2408015 mat matt matova матовый	56 ks	-	-	-
				-	6,5	-
				-	50	-

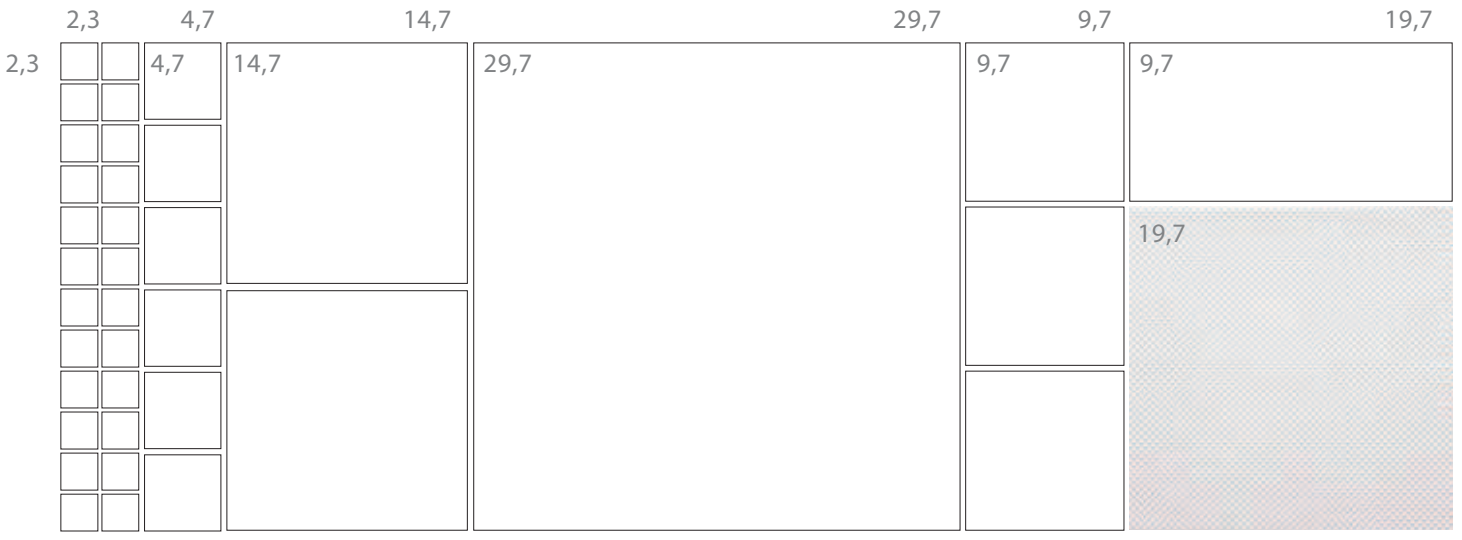

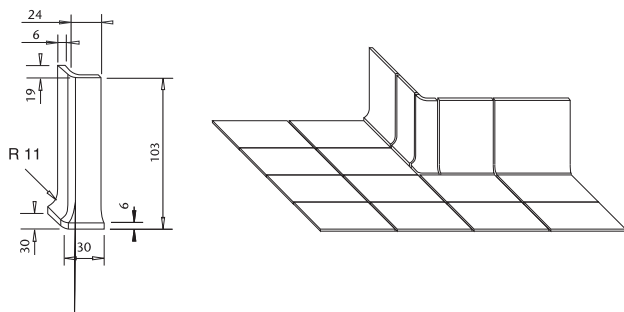

sokl vnější roh | skirting outside corner (GSERCxxx)

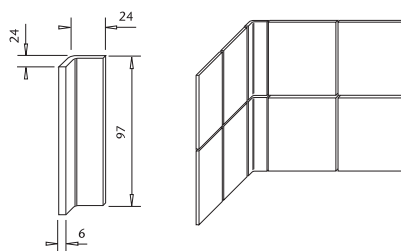

průběžná hrana vnitřní | shover piece - inside edge (GSIA5xxx)

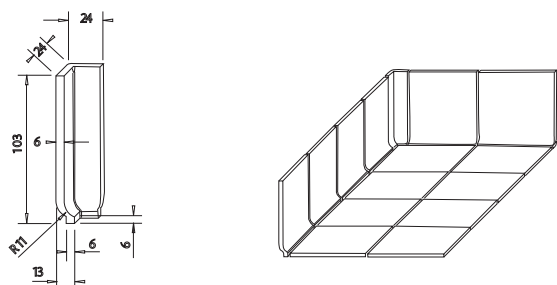

sokl vnitřní roh | skirting inside corner (GSIRCxxx)

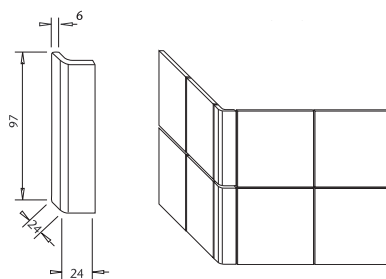

průběžná hrana vnější | shover piece - outside edge (GSEA5xxx)

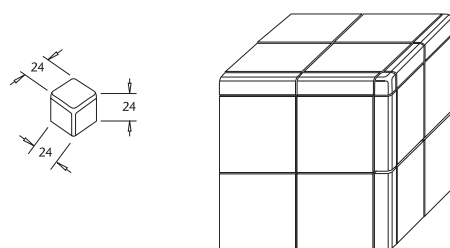

vnější roh | outside corner (GTVR4xxx)

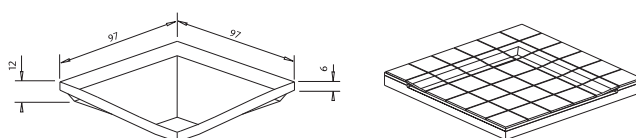

bezbarierová tvarovka rohová | shover piece - corner (GTRONxxx)

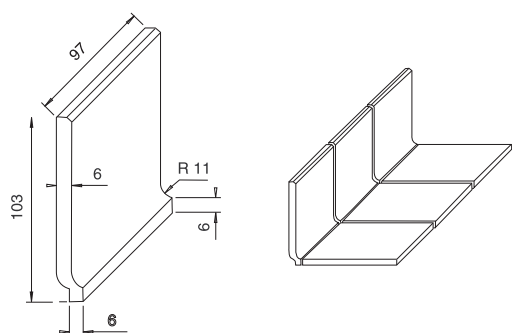

sokl s pozlábkem | cove skirting (GSPOJxxx, GSTONxxx)

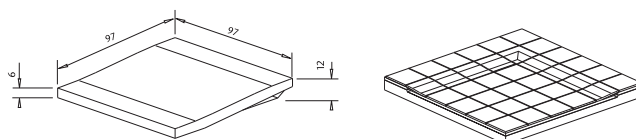

bezbarierová tvarovka průběžná | shover piece - continuous (GTPONxxx)